

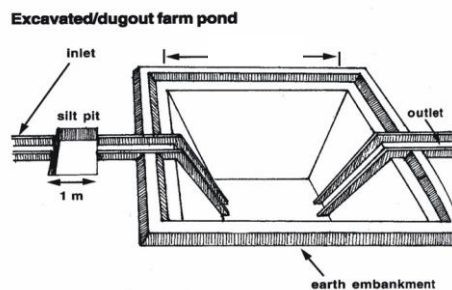

# Plan on Artificial Recharge to Groundwater and Water Conservation in Palepalli Firka, Krishnagiri Taluk, Krishnagiri District, Tamil Nadu

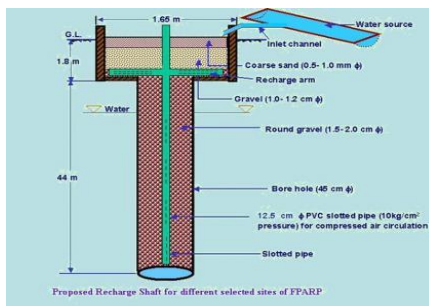

By

Central Ground Water Board  
South Eastern Coastal Region  
Rajaji Bhawan, Besant Nagar  
Chennai

## Content

<b>S. No.</b>	<b>TOPIC</b>
	At a Glance
1	Introduction
2	Objectives
3.	Study area details
	3.1 Location
	3.2 Geomorphological Setup
	3.3 Landuse and Soil
	3.4 Drainage
	3.5 Rainfall
	3.6 Hydrogeology
	3.7 Dynamic Ground water Resources
4	Spatial data integration/ conservation
5	Planning for recharge
	5.1 Justification of the artificial recharge
	5.2 Availability of surplus surface water for artificial recharge or conservation
	5.3 Proposed interventions including tentative location of artificial recharge structures and water conservation
	5.3.1 Artificial recharge
	5.3.1.1 Check Dam /Nala Bund
	5.3.1.2 Recharge shaft
	5.3.1.3. Revival , repair of water bodies
	5.3.2. Water Conservation Measure
	5.3.2.1 Farm Pond
	5.3.2.2 Micro irrigation system
6.	Tentative Cost Estimation
7.	Implication modalities
	a) Time schedule
	b) Operation and Maintenance

<b>AT A GLANCE</b>	
Name of Firka	Palepalli
Taluk	Krishnagiri
District	Krishnagiri
State	Tamil Nadu
Total area	147.27 Sq.km
Total area suitable for groundwater recharge	101.58 Sq.km (69%)
Lat. & Lon.	12°25' 46 "to 12° 40'39" & 78°14' 39"to 78°20' 23".
Rainfall	1068 mm
Monsoon	837 mm
Non- Mon soon	231 mm
Geology	Crystalline metamorphic gneiss complex comprising Hornblende gneiss
<b>WATER LEVEL</b>	
Pre - Monsoon	10 to 20 m bgl.
Post - Monsoon	5 to 10 m bgl.
<b>GROUND WATER RESOURCES ESTIMATION</b>	
Replenish able ground water resources	14.7251 MCM
Net ground water available	13.2526 MCM
Ground water draft for irrigation	21.2045 MCM
Groundwater draft for domestic & industrial water supply	0.6327 MCM
Total ground water draft	21.8372 MCM
Stage of ground water development (%)	165 %
Uncommitted surface runoff available for the Firka	18.49 MCM
Total volume of weathered zone	1178 MCM
Total volume available for recharge (considering 3 m depth from 3 m bgl)	736 MCM
<b>ARTIFICIAL RECHARGE / CONSERVATION MEASURES</b>	
No. of Structures Proposed ( tentative)	
Masonry Check dam –	11
Percolation Pond with recharge shaft –	6
Revival, repair of pond, tanks with recharge shaft –	7
Recharge shaft –	13
Improving Water Efficiency /Saving (Micro irrigation system for 100 ha )	0.7 MCM
Excepted groundwater recharge	1.5656MCM
Excepted total groundwater recharge/saving	2.2656 MCM
Tentative total cost of the project	Rs. 5.74 Cr
Expected raise in water level by	0.44 m

recharging/saving	
-------------------	--

# **Plan on Artificial Recharge to Groundwater and Water Conservation in Palepalli Firka, Krishnagiri Taluk, Krishnagiri district, Tamil Nadu**

## **1. Introduction**

India is the largest user of groundwater in the world. Food grain security of the country is largely dependent on water resources and groundwater resources play major role in irrigation sector. Imprints of Over-Exploitation on groundwater resources are being observed as steep deepening of water levels, drying of shallow groundwater abstraction structures, ingress of salinity in fresh aquifers etc. which signal towards taking necessity of emergent action for artificial recharge and rainwater harvesting by utilizing surplus runoff and maintaining groundwater resources at sustainable stage.

In Tamil Nadu dependency on groundwater has increased many folds during the recent years and the groundwater extraction for irrigation, domestic and industries have resulted in lowering of water levels, long-term water level declining trend and even drying up of wells. In order to regulate the groundwater development, Central Ground Water Board in association with State Ground Water Departments has computed Dynamic Groundwater Resources and categorized blocks as Over Exploited, Critical, Semi Critical and Safe.

Out of 1129 firkas (assessment units) in Tamil Nadu the groundwater situation in 374 firkas over-exploited, 48 firkas critical, 235 firkas semi-critical, 437 firkas safe and 35 firkas are saline. Various measures such as rainwater harvesting, artificial recharge and water use efficiency are successfully practiced by some NGOs, Central and State Govts., which need replication at larger scale in close coordination with State govt. agencies and stakeholders so that capacity building of state implementing agencies and awareness of stakeholders towards artificial recharge and rainwater harvesting can be made.

## **2. Objectives of the scheme**

Objectives of the proposed scheme are

- To upscale recharge activities, supplement additional groundwater resources by harvesting surplus runoff, sustainability of groundwater resources at shallow depths
- Recovery of over-exploited groundwater areas by implementing artificial recharge measures in groundwater stress areas.
- Conservation, development and sustainable management of natural resources including their use.

### 3. Study area details

#### 3.1 Location

The total area of Palepalli firka is 147.27 sq.km and Palepalli firka lies between North latitudes 12°25' 46 "to 12° 40'39" and east longitudes 78°14' 39"to 78°20' 23". Location map of Palepalli firka is given in Figure 1.

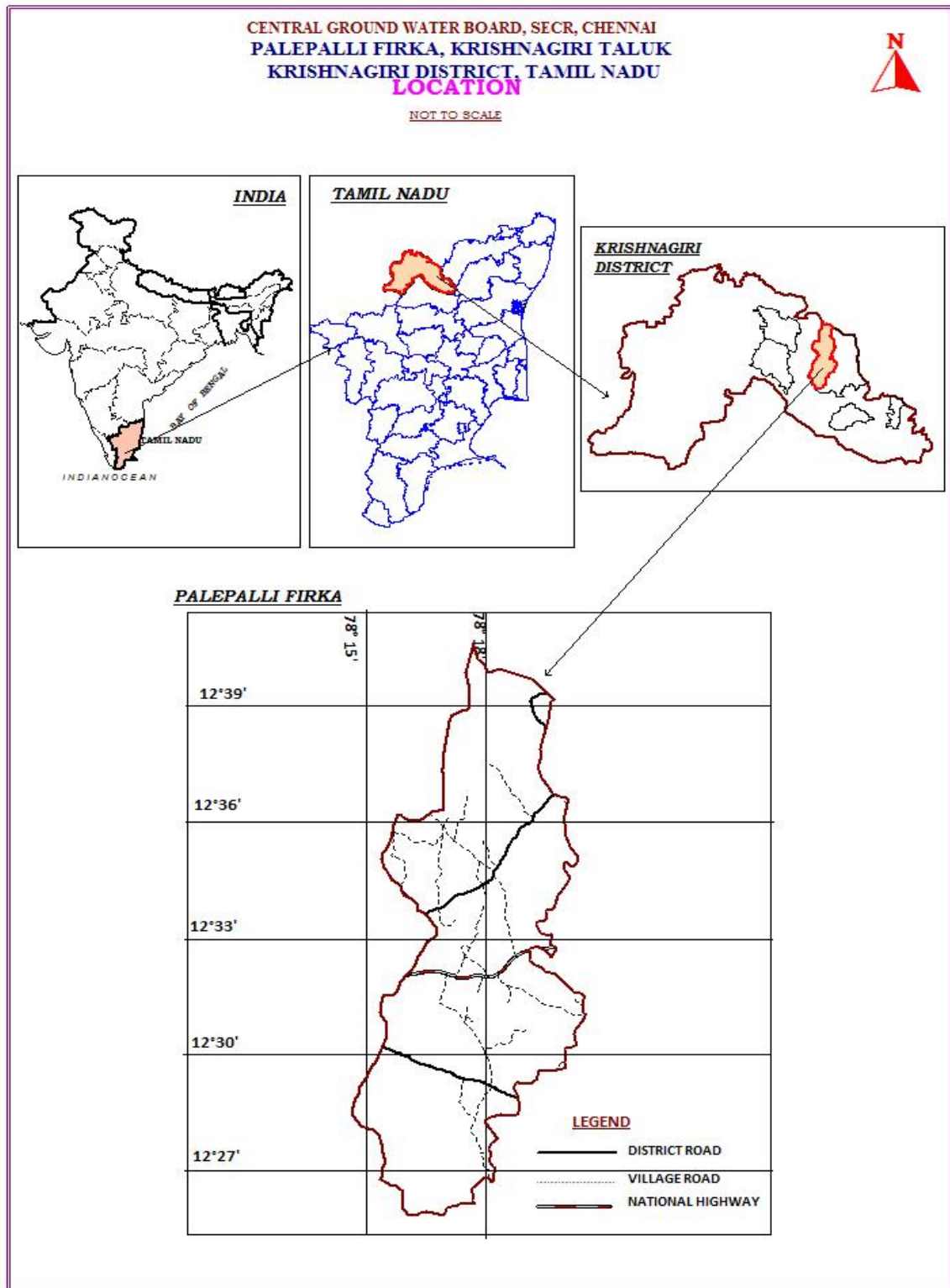

### Figure 1. Location map of Palepalli firka

#### 3.2 Geomorphological Set up

Geomorphologically, the area consists of hills and plain landforms. In plain landforms, Pediplain weathered moderate and shallow are occupied major part of the firka. These landforms are influencing the ground water recharge. Hill landform like residual hills, denudation hill and structural hills are act as runoff zone. (*Source: IRS, Anna University, Chennai Tamil Nadu*). Geomorphological map prepared using IRS- 1D data on 1: 50,000 scale and units are as per NNRMS standards. The various geomorphological units with its % of coverage area are given in Table 1 and shown in Figure 2.

**Table – 1. Various geomorphological units with its % of coverage area in Palepalli firka**

<b>LANDFORMS</b>	<b>% of Area</b>
Deep	3.07
Deflection Slope	5.47
Denudational Hills / Residual Hills	23.01
Dissected/Undissected	27.18
Highly Dissected	0.16
Inselberg	0.64
Moderate	15.97
Pediment-Inselberg Complex	4.08
Shallow	20.42





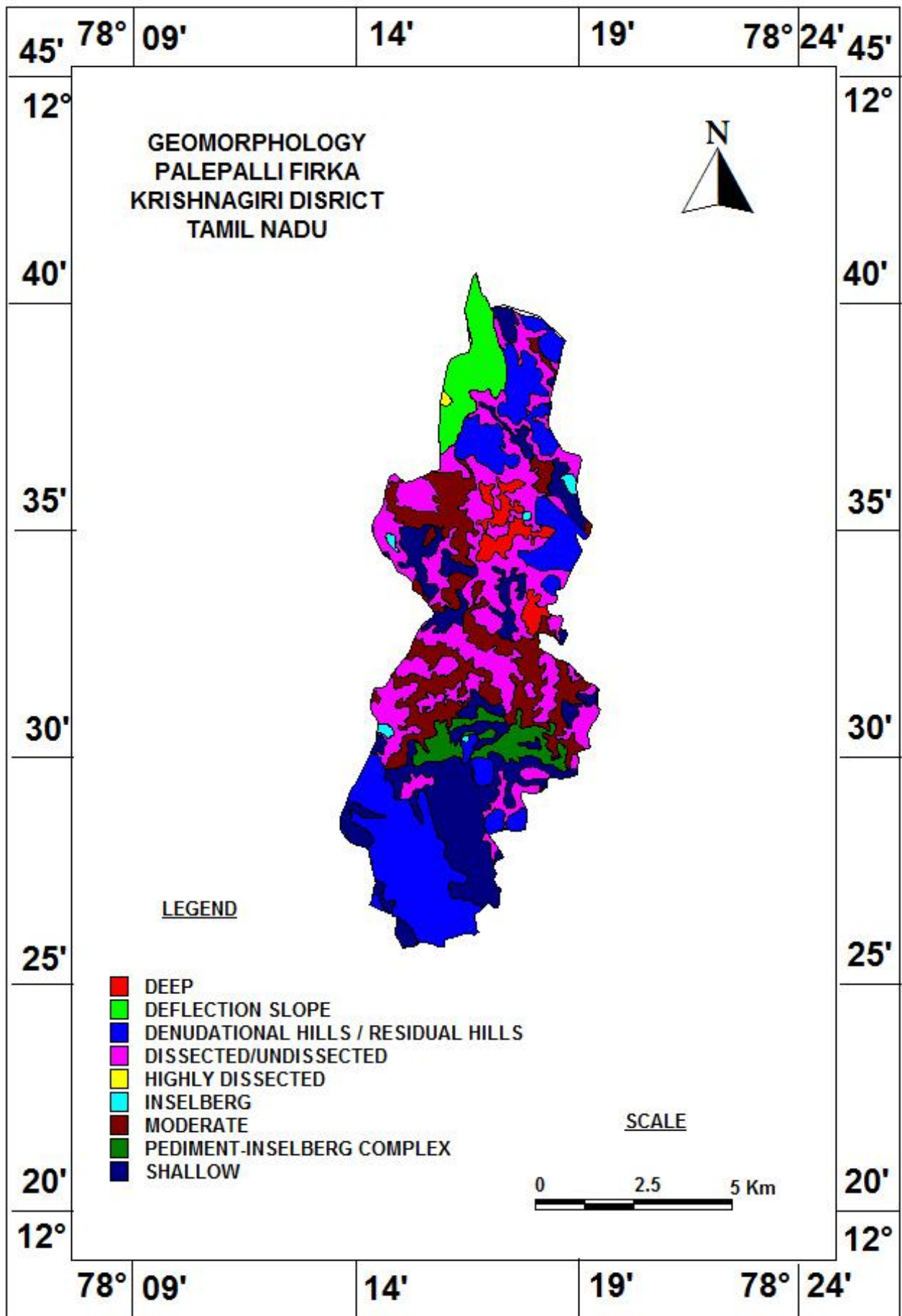

Figure 2. Geomorphology of Palepalli firka

### 3.3 Land use and soil

The land use pattern of the Palepalli firka is given in Figure 3. Predominantly the most of the area is characterised by the wet crop, plantation and dry crop (i.e., agricultural field) and accounts for 50 % of the total area of the firka (Source: IRS, Anna University, Chennai Tamil Nadu). This area is highly suitable for water conservation and recharge. The entire Firka is occupied by rock outcrops with loamy soil.

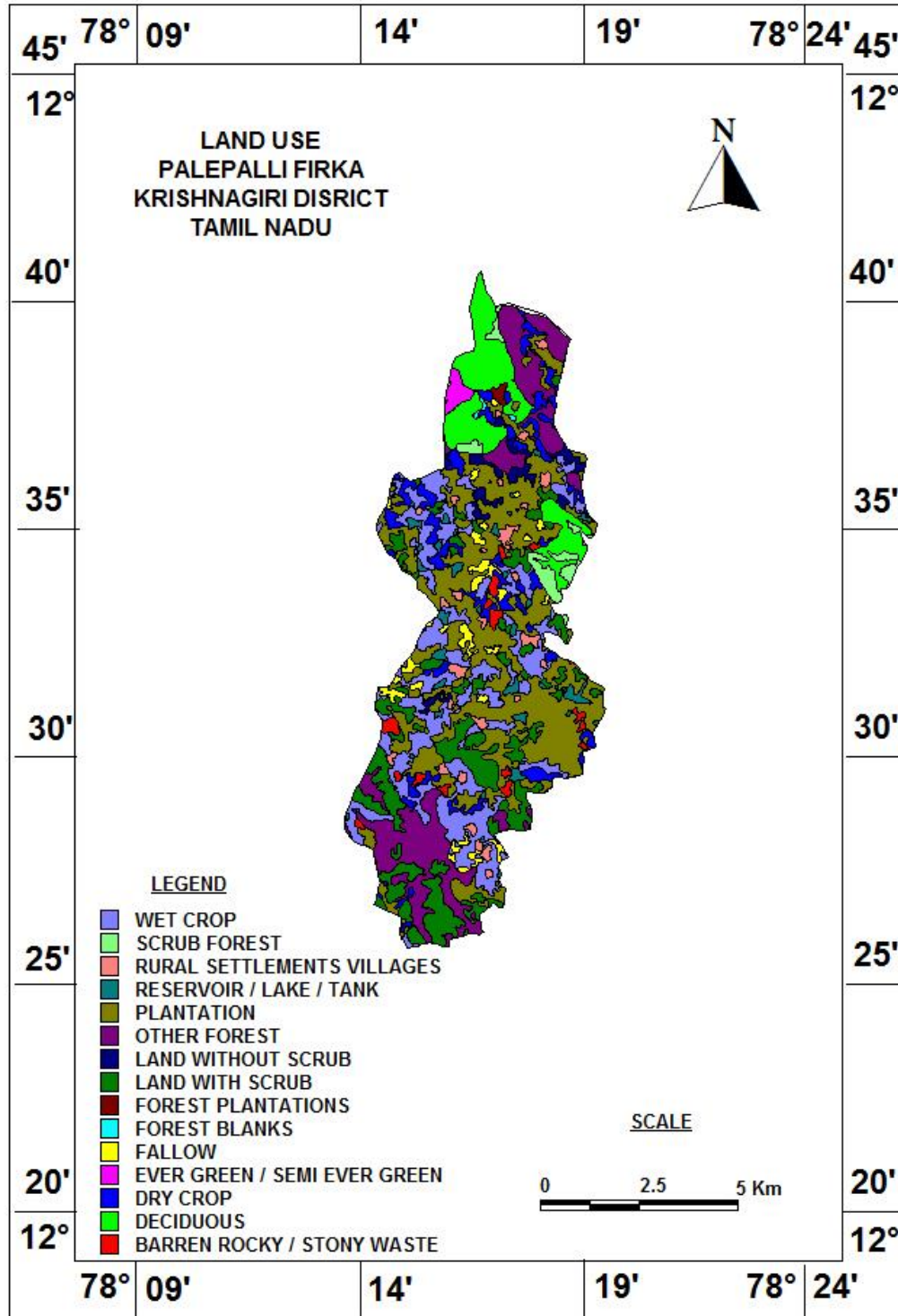

Figure 3. Land use map of Palepalli firka

### 3.4 Drainage

The drainage pattern is the dendritic and sub- dendritic. The drainage map of Palepalli firka is given in Figure 4.

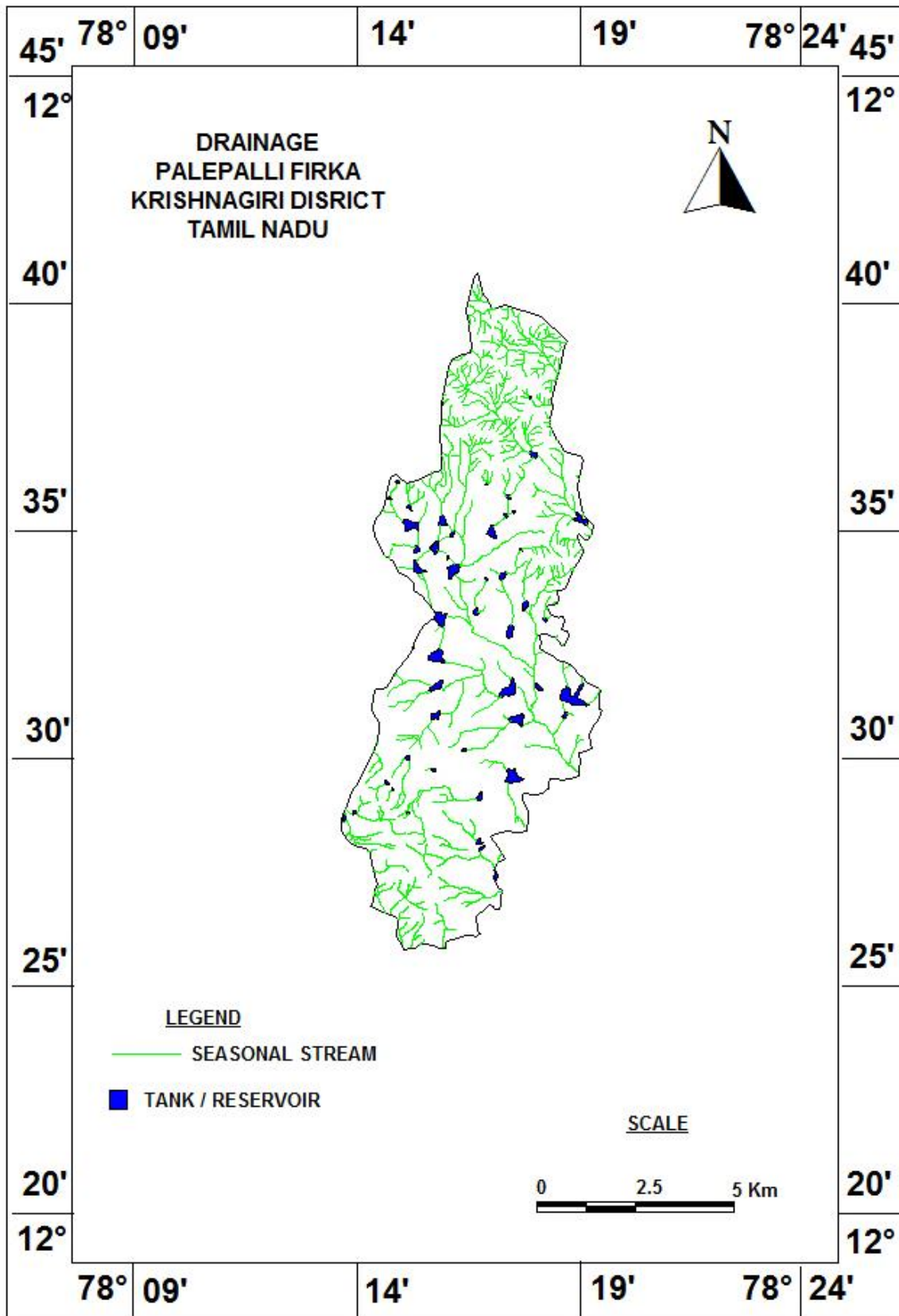

Figure 4. Drainage map of Palepalli firka

### 3.5 Rainfall

Palepalli area falls under tropical climate with temperature in the summer months of March to May. The average temperature varies from 26 to 41° C. The humidity is also high in the order of 80%. The wind speed is high during the months of July and August. The wind speed ranges from 7.4 to 12.6 km/hr, which increases from 100 to 120 km/hr during cyclone period. Palepalli firkareceives rainfall from southwest monsoon (June – September), northeast monsoon (October – December) and non-monsoon periods (January – May). The area receives the major rainfall from northeast monsoon. Rainfall is generally heavy during low-pressure depressions and cyclones during the northeast monsoon period. The normal annual rainfall is 1.068 mm.

Taluk	Name of Firkas	Area in sq.km	Monsoon rainfall (Jun to Dec) In m	Non monsoon rainfall (Jan – May) In m	Total Rainfall In m
Palepalli	Palepalli	147.27	0.837	0.231	1.068

### 3.6 Hydrogeology

The entire firka is underlain by the crystalline metamorphic gneiss complex consisting of gneiss and granite. Ground water is occurring in pheratic conditions in weathered and fractured gneiss rock formation. The weathering is highly erratic and the depth of abstraction structures is controlled by the intensity of weathering and fracturing. Large diameter dug well is more common ground water abstraction structures in the area. The diameter of the dug well is in the range of 7 to 10 m and depth of dug wells range from 15 to 18 m bgl. The dug wells yield up to 1 lps in summer months and few wells remains dry. The yield is adequate for irrigation for one or two crops in monsoon period.

The depth of wells varies from 6.64 to 17 m bgl. The hydrogeological map of Palepalli firka is given in Figure 5. Decadal mean water level of pre-monsoon and post monsoon are given in Figures 6 a & b. The decadal maps reveal that, mean water level during pre-monsoon in majority area is < 5 m bgl likewise during post monsoon majority part is under < 5m ground water level. The present water level in the firka is in the range of 10 to 20 mbgl (May).

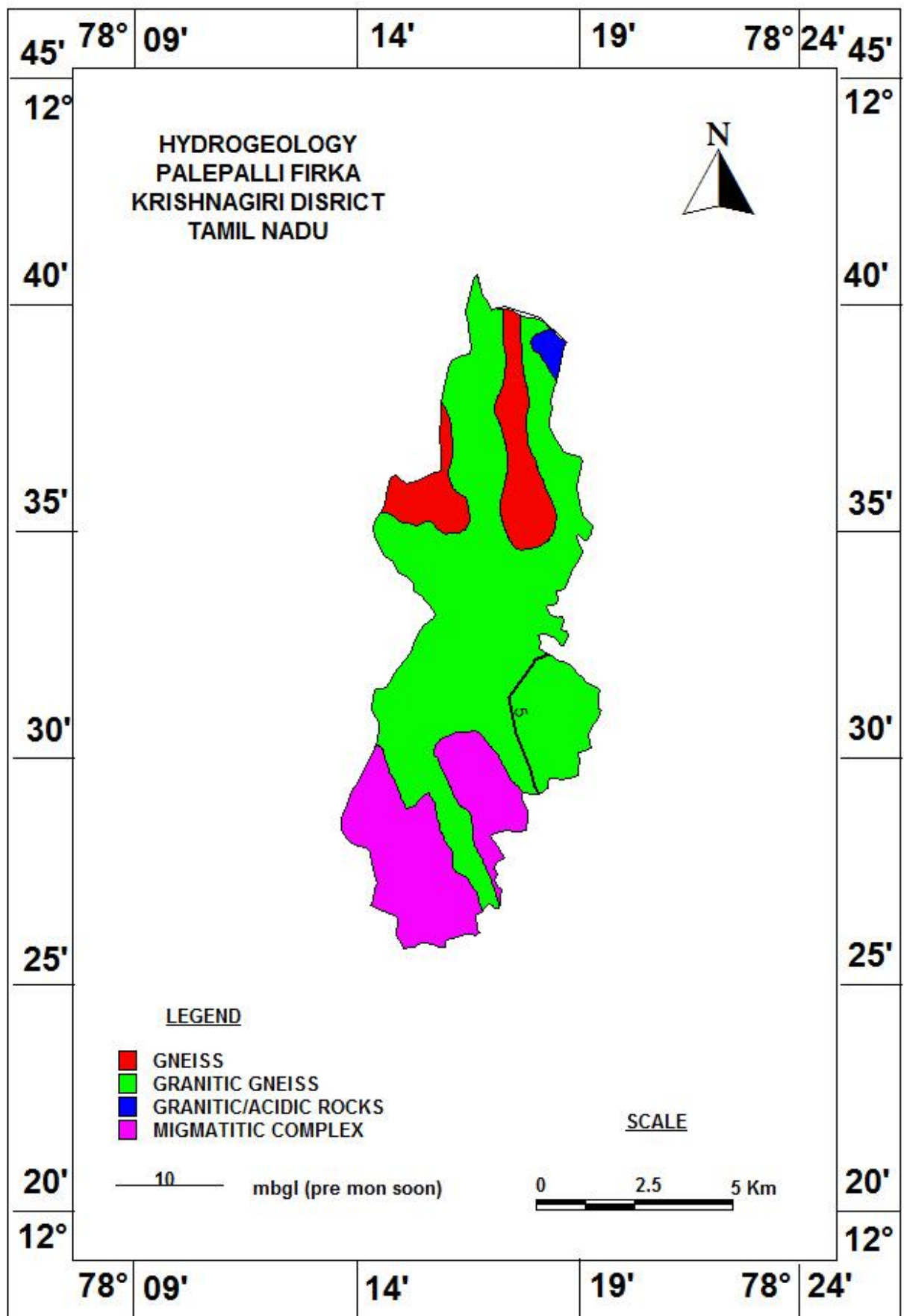

Figure 5. Hydrogeological Map of Palepalli firka

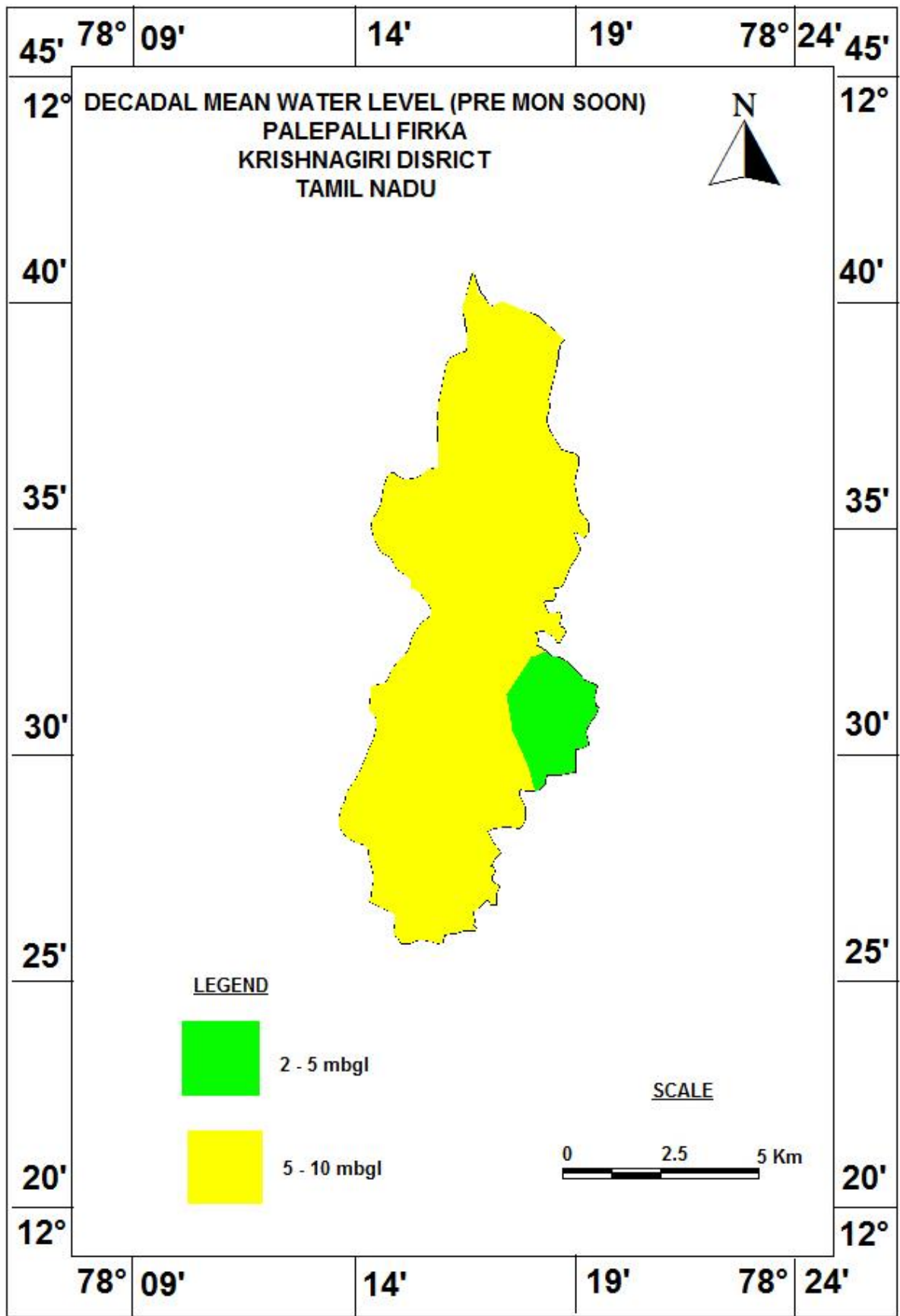

Figure 6a. Decadal Pre -monsoon water level in Palepalli firka



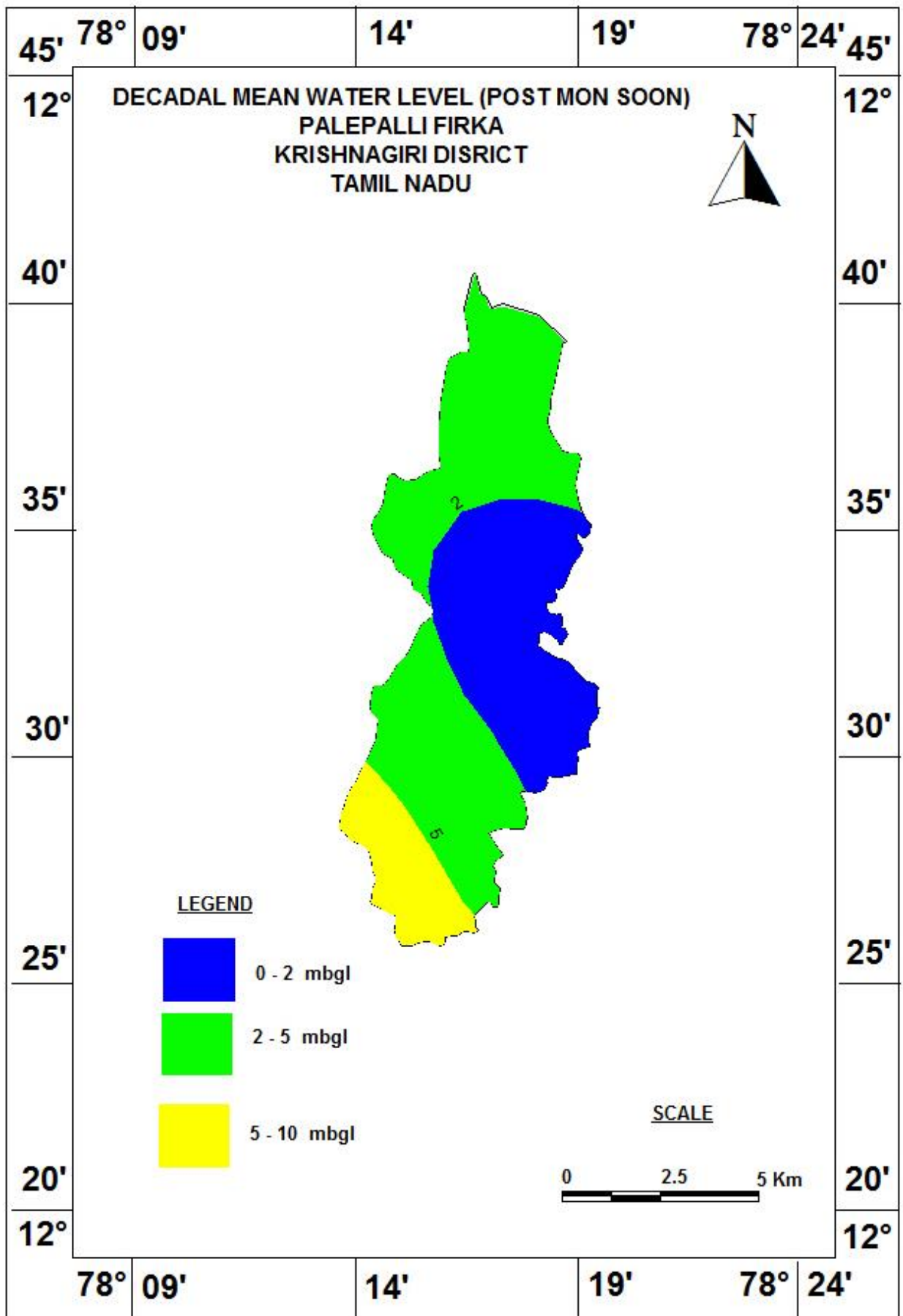

Figure 6 b. Decadal Post-monsoon water level in Palepalli firka



### 3.7 Dynamic Ground water Resources

The ground water resources have been computed jointly by Central Ground Water Board and State Ground Water Resources Data Centre (PWD, WRO, Govt. of Tamil Nadu) as on 31st March 2011. The computation has been done using GEC1997 methodology. The salient features of the computations are furnished in Table 2.

**Table 2. Dynamic Ground water resources estimation of Palepalli firka**

Firka	GW WORTHY AREA	REPLENISH ABLE GROUND WATER RESOURCES	NET GROUND WATER AVAILABLE	GROUND WATER DRAFT FOR IRRIGATION	GROUNDWATER DRAFT FOR DOMESTIC & INDUSTRIAL WATER SUPPLY	TOTAL GROUND WATER DRAFT	STAGE OF GROUND WATER DEVELOPMENT (%)	CATEGORY
	(Sq. Km)	( MCM)					(%)	
Palepalli	147.27	14.7251	13.2526	21.2045	0.6327	21.8372	165	OVER EXPLOITED

### 4. Spatial Data Integration

The potential area for groundwater recharge is highly influenced by Geology, Geomorphology, Land use /land cover, Drainage, Surface Water Body, Weathered Thickness and first fractured Depth in the area. In order to ascertain the suitable area for groundwater recharge in firka, spatial data integration of have been attempted using index overlay model in GIS environ. In this model, seven layers have been integrated by assigning weightage for the theme having scale of 1-100 and sub-classes of the theme between 1 to 10 scales. The resultant map has been reclassified into four classes (High-low integrated values) indicating the suitable area for artificial recharge and given in Figure -7 and described below.

ZONE	% OF AREA COVERAGE	SIGNIFICANCE*
Very high	3	Suitable for all major recharge structures like Percolation pond and stop dam, check dam etc.,
High	29	Suitable for all major recharge structures like stop dam, check dam etc.,
Moderate	37	Suitable for all major recharge structures like earthen check dam, Boulder check dam and Nala bund etc.,
Poor	31	Hilly/Forest /Catchment area

\*However, the filed verification is required to confirm above potential area for groundwater recharge.

**AREA SUITABLE FOR GROUNDWATER RECHARGE  
PALEPALLI FIRKA  
KRISHNAGIRI TALUK  
KRISHNAGIRI DISTRICT  
TAMIL NADU**

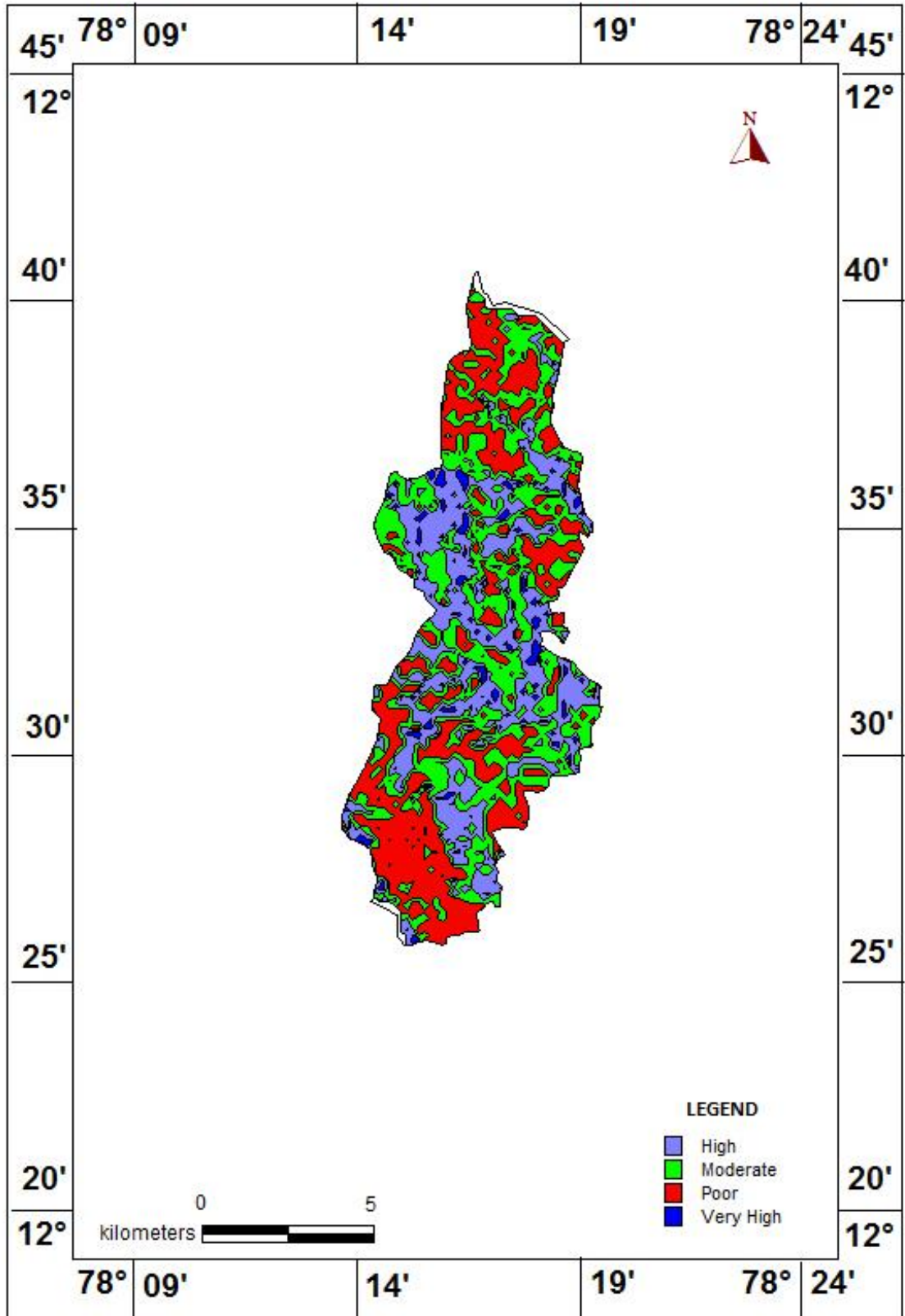

**Figure – 7 Recharge worthy area**

## **5. Planning for groundwater recharge /conservation**

### **5.1 Justification of the artificial recharge & conservation measures**

- ❖ The Firka is with high stage of groundwater development i.e., 165 % and with sufficient amount of uncommitted surface runoff/flow of 18.49 MCM.
- ❖ The total weathered zone available beneath the ground in the firka is 1178 MCM. Out of these, total volume available for recharge considering 5m is 736 MCM.
- ❖ The Firka consists of many surface water bodies /lakes and are well connected by the drainage. Revival and Recharge of these ponds will enhance the sustainability of the ground water abstraction structures.
- ❖ However, most of the ground water developments for agricultural purposes are met through dug-cum bore well and bore wells only. Hence, there is sufficient scope of recharge.
- ❖ Model generated in the areas reveals that more than 69 % of areas are suitable for recharge.
- ❖ In firka more than 50 % area is characterised by the agricultural activities, there is sufficient scope for the water conservation measures for enhance the crop production and better ground water development.

### **5.2 Availability of surplus surface water for artificial recharge or conservation**

The uncommitted surface flow for Firka is estimated as per the norms followed by State Ground & Surface Water Resources data centre, PWD, Taramani, Chennai (Aug 2015). The available of surplus surface water for Firka is 18.49 MCM.

### **5.3 Proposed interventions including tentative location of artificial recharge /conservation measures**

On basis of above description the following three type of approach have been made to propose artificial recharge or conservation structures.

- a. Artificial recharge
- b. Water conservation measure
- c. Water Efficiency

#### **5.3.1 Artificial recharge**

The details of artificial recharge structure proposed along with justification are given below.

##### **5.3.1.1 Check dam**

The seasonal drains in the firka carry heavy discharge during monsoon period. It is proposed that such seasonal streams / rivers will be identified and harnessed its seasonal water through construction of series of check dams. This will help in recharge to groundwater by increasing contact period between surface water and groundwater.

As per the integrated model prediction around 69 % of the firka areas are suitable for these structures. It is proposed to construct 11 Check dam. The tentative location of these 11 ARs are given below and shown in Plate 1. The size and location of these structures are tentative and details field survey is essential to ascertain the exact size and location.

#### **Tentative location of proposed 11 Check dam in the firka**

<b>S. No.</b>	<b>Longitude</b>	<b>Latitude</b>	<b>Structures</b>
1	78.32	12.65	Check dam
2	78.32	12.64	Check dam
3	78.30	12.62	Check dam
4	78.31	12.62	Check dam
5	78.32	12.60	Check dam
6	78.33	12.59	Check dam
7	78.29	12.60	Check dam
8	78.30	12.55	Check dam
9	78.32	12.53	Check dam
10	78.33	12.50	Check dam
11	78.30	12.45	Check dam

#### **5.3.1.2 Recharge shaft**

A recharge shaft has been proposed to facilitate the groundwater recharge in the surface water body. It has been proposed in the reservoir of the proposed revival pond and percolation pond in the firka. A total of 13-recharge shaft has been proposed in this firka. The tentative location of recharge shaft is given in the map and presented in the given table.

#### **5.3.1.3. Revival, repair of water bodies**

The village tanks and ponds are source for the groundwater recharge. Several such villages ponds/ tanks are in dilapidated condition. These existing village tanks which are normally silted and damaged can be modified to serve as recharge structure in case these are suitably located to serve as percolation tanks. Through de-silting, coupled with providing proper waste weir, the village tanks can be converted into recharge structure. The locations of about 13 existing ponds/tanks have been identified with latitude and longitude given below and marked on Plate 1. Of 13, 7 tanks/ponds have been proposed to taken up for the renovation with recharge shaft.

The remaining 6 tanks falling in the very high zone have been selected for the percolation tank with recharge shaft.

### **Tentative location of proposed de-siltation of pond/tanks with recharge shaft**

<b>S. No.</b>	<b>Longitude</b>	<b>Latitude</b>	<b>Structure</b>	<b>Action</b>
1	78.32	12.65	Tank / Reservoir	De-siltation And Recharge Shaft
2	78.32	12.64	Tank / Reservoir	De-siltation And Recharge Shaft
3	78.30	12.62	Tank / Reservoir	De-siltation And Recharge Shaft
4	78.31	12.62	Tank / Reservoir	De-siltation And Recharge Shaft
5	78.32	12.60	Tank / Reservoir	De-siltation And Recharge Shaft
6	78.33	12.59	Tank / Reservoir	De-siltation And Recharge Shaft
7	78.29	12.60	Tank / Reservoir	De-siltation And Recharge Shaft

### **Tentative location of proposed Percolation pond/tanks with recharge shaft**

<b>S. No.</b>	<b>Longitude</b>	<b>Latitude</b>	<b>Structure</b>	<b>Action</b>
1	78.27	12.58	Tank / Reservoir	Percolation Tank With Shaft
2	78.29	12.57	Tank / Reservoir	Percolation Tank With Shaft
3	78.28	12.55	Tank / Reservoir	Percolation Tank With Shaft
4	78.31	12.52	Tank / Reservoir	Percolation Tank With Shaft
5	78.33	12.52	Tank / Reservoir	Percolation Tank With Shaft
6	78.33	12.59	Tank / Reservoir	Percolation Tank With Shaft

## **5.3.2 Water conservation measure**

### **5.3.2.1 Farm Pond**

A farm pond is a large dug out in the earth, usually square or rectangular in shape, which harvests rainwater and stores it for future use. It has an inlet to regulate inflow and an outlet to discharge excess water. The pond is surrounded by a small bund, which prevents erosion on the banks of the pond. The size and depth depend on the amount of land available, the type of soil, the farmer's water requirements, the cost of excavation, and the possible uses of the excavated earth. Water from the farm pond is conveyed to the fields manually, by pumping, or by both methods.

## Advantages of Farm Ponds

- They provide water to start growing crops, without waiting for rain to fall.
- They provide irrigation water during dry spells between rainfalls. This increases the yield, the number of crops in one year, and the diversity of crops that can be grown.
- Bunds can be used to raise vegetables and fruit trees, thus supplying the farm household with an additional source of income and of nutritious food.
- Farmers are able to apply adequate farm inputs and perform farming operations at the appropriate time, thus increasing their productivity and their confidence in farming.
- They check soil erosion and minimize siltation of waterways and reservoirs.
- They supplies water for domestic purposes and livestock
- They promote fish rearing.
- They recharge the ground water.
- They improve drainage.
- The excavated earth has a very high value and can be used to enrich soil in the fields, levelling land, and constructing farm roads

As per the Land use classification of the firka, majority of the area is covered by the agricultural field. Hence it is proposed to construct 100 farm ponds as per the specification of AED, Govt. of Tamil Nadu.

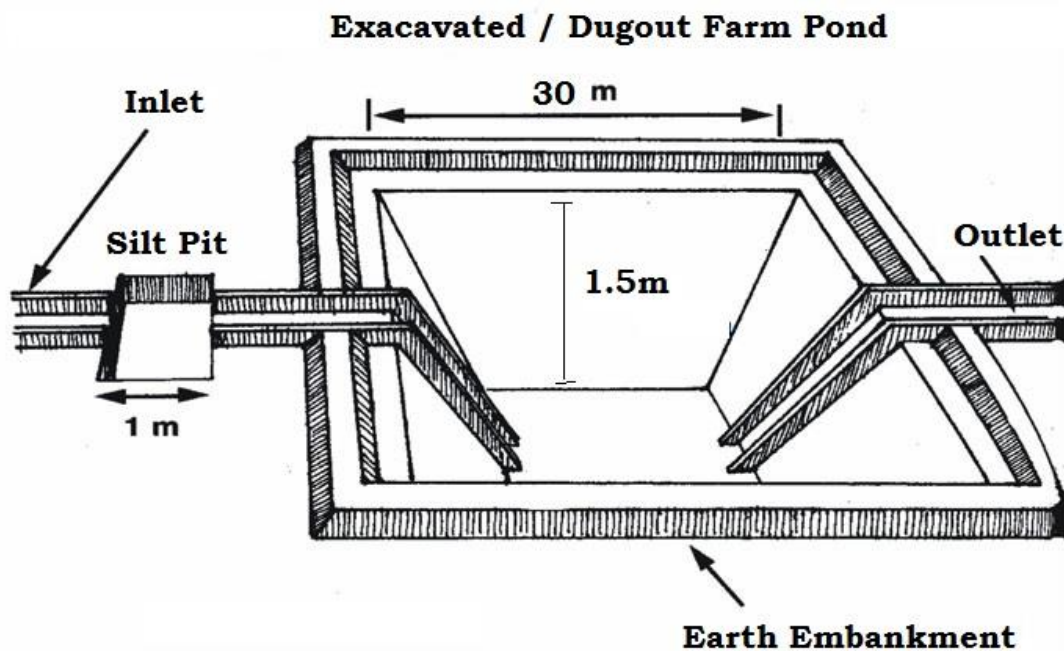

### 5.3.2.2. Micro Irrigation System (Sprinkler/ drip/ HDPE pipes)

Micro irrigation is defined as the frequent application of small quantities of water directly above and below the soil surface; usually as discrete drops, continuous drops or tiny streams through emitters placed along a water delivery line.

In flood/furrow irrigation method more than 50% of applied water is wasted through seepage to deeper level, localized inundation causes loss through evaporation and it leaches out the nutrients from the plant. While through drip & sprinkler irrigation wastage of irrigational water could be minimized. The studies on different crops, has revealed that irrigation water is saved drastically. The conveyance losses (mainly seepage & evaporation) can be saved up to 25 to

40% through utilization of HDPE pipes. Initially the scheme is proposed to be implemented in worst affected areas showing deepest water levels and significant declining trends.

It is proposed to take up micro irrigation system in 100 ha. The cost estimation for this component has been taken from SOR of Agricultural Engineering Department (AED), Govt. of Tamil Nadu. Tentative locations of proposed micro irrigation are shown in Figure 7.

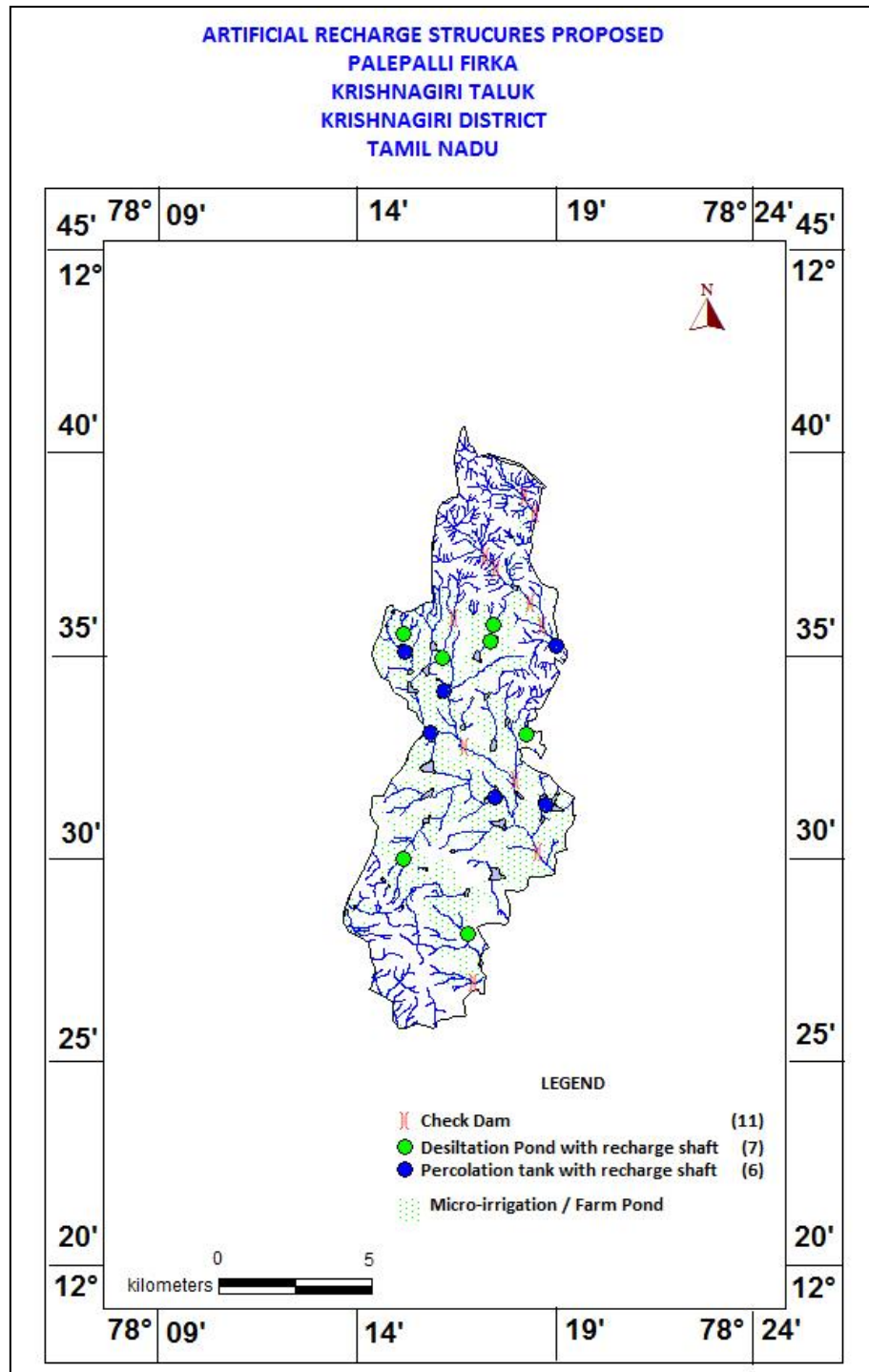

Figure 7. Location map showing the proposed AR Structures

## 6. Tentative Cost Estimation

A tentative number of feasible structures, its cost and expected annual groundwater recharge / water saving is given in the Table 7. The unit rates are as followed by the PWD, Govt. of Tamil Nadu (Sources: Schedule of rates, Govt. of Tamil Nadu 2015).



**Table 7. Showing the Cost Estimation of proposed Artificial Recharge Structures**

Feasible Artificial Recharge & Water Conservation structures/ activities	Tentative Design	Quantity (in nos. or area in sq. m)	Total volume (cu.m )	Tentative unit cost (in Rs lakh)	Total tentative cost (in Rs lakh)	Expected Annual GW recharge / Saving (cu.m)
<b>Recharge Structures/ Activities</b>						
Masonry Check dams (5 Fillings)	Crest- 10 -15 m; Height- 1 – 1.5 m	11	187000	9	99	149600
Percolation pond	150x150x1.5m	6	607500	25.0	150	486000
Revival, repair of water bodies (3 Fillings)	(100mx100mx2.5m)	7	150000	12.0	84	420000
Recharge shaft with the pond /tanks	Recharge shaft of 1.5 m dia. With 2m depth with filter media in lower 1 m Bore dia 10” Casing 6” Depth 30 m	13		2.0	26	
<b>Water Conservation Activities</b>						
Farm Pond (in ha) (5 Fillings)	( 30 m x 30m x 1.5 m)	100Units	600000	1	100	510000
Sprinkler/ drip/ HDPE pipes	For 1 ha with 5 m interval HDPE pipe	100 ha	500000	0.6 /ha	60	700000
<b>Subtotal - I</b>					<b>519</b>	<b>2265600</b>
<b>Impact assessment and O &amp; M</b>						
Piezometers Up to 50 m bgl – 4 nos. @ 0.6 lakh					<b>2.4</b>	
<b>Subtotal - II</b>					<b>521.4</b>	
<b>O &amp; M - 5 % of Subtotal - II</b>					<b>26.07</b>	
Impact assessment to be carried out by the implementing agencies @5 % of Subtotal - II					<b>26.07</b>	
<b>TENTATIVE TOTAL COST OF THE PROJECT</b>					<b>573.54</b>	

Note:

- The type, number and cost of structure may vary according to site, after the ground truth verification
- CD, PC – the storage of Check Dams and Percolation Ponds is also proposed for irrigating surrounding areas for enhancing groundwater recharge as well as effective utilization of the artificial recharge structures.

## **7. Implication modalities**

The implementation of the scheme will be done by the line department of the state selected by the respective State authority. Further, it is to add that more than 50 % MGNREGA

works related to water conservation/sustainable management, accordingly a convergence guideline has been made between National Rural Employment Guarantee Act (NREGA) (Ministry of Rural Development) & Programmes of Water Resources (MoWR , RD & GR). The district Krishnagiri among the list of districts identified for Convergence between NREGS and schemes of MoWR. The details of permissible works under convergence are envisaged in the Joint Convergence Guideline.

**a.) Time schedule**

<b>Steps</b>	<b>1<sup>st</sup> Quarter</b>	<b>2<sup>th</sup> Quarter</b>	<b>3<sup>rd</sup> Quarter</b>	<b>4<sup>th</sup> Quarter</b>	<b>5<sup>th</sup> Quarter</b>	<b>6<sup>th</sup> Quarter</b>	<b>7<sup>th</sup> Quarter</b>	<b>8<sup>th</sup> Quarter</b>
❖ Identification of line department /implementing agency and preparation of DPR								
❖ Approval of scheme and release of sanction of funds								
❖ Implementation of ARS								

**Phase = one quarter or 3 months or equivalent to financial quarter**

**b.) Operation and maintenance**

In all projects Impact assessment has to be carried out to ensure that projects is economically viable, socially equitable and environmentally sustainable by inter-related socio-economic, cultural and human-health impacts, both beneficial and adverse. Accordingly it is proposed to have impact assessment at rate of 5 % of the total cost of the project for 5 years from the completion of artificial recharge.