

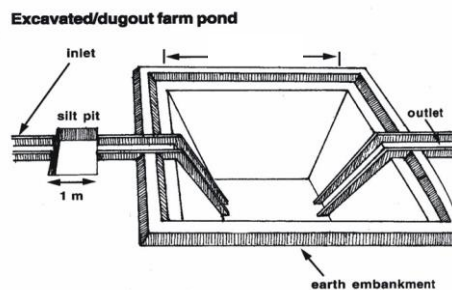

Plan on Artificial Recharge to Groundwater and Water Conservation in Krishnagiri Firka, Krishnagiri Taluk, Krishnagiri District, Tamil Nadu

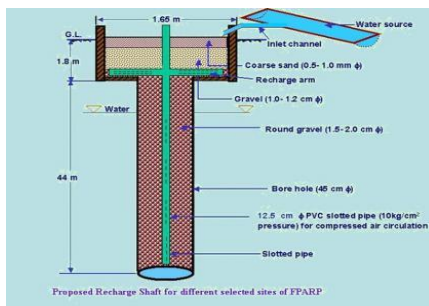

By

Central Ground Water Board
South Eastern Coastal Region
Rajaji Bhawan, Besant Nagar
Chennai

Content

S. No.	TOPIC
	At a Glance
1	Introduction
2	Objectives
3.	Study area details
	3.1 Location
	3.2 Geomorphological Setup
	3.3 Land use and Soil
	3.4 Drainage
	3.5 Rainfall
	3.6 Hydrogeology
	3.7 Dynamic Ground water Resources
4	Spatial data integration/ conservation
5	Planning for recharge
	5.1 Justification of the artificial recharge
	5.2 Availability of surplus surface water for artificial recharge or conservation
	5.3 Proposed interventions including tentative location of artificial recharge structures and water conservation
	5.3.1 Artificial recharge
	5.3.1.1 Check Dam /Nala Bund
	5.3.1.2 Recharge shaft
	5.3.1.3. Revival , repair of water bodies
	5.3.2. Water Conservation Measure
	5.3.2.1 Farm Pond
	5.3.2.2 Micro irrigation system
6.	Tentative Cost Estimation
7.	Implication modalities
	a) Time schedule
	b) Operation and Maintenance
8.	Ground Truth Verification

AT A GLANCE	
Name of Firka	Krishangiri
Taluk	Krishnagiri
District	Krishnagiri
State	Tamil Nadu
Total area	146.58 Sq. Km.
Total area suitable for groundwater recharge	95.23 Sq. Km. (65%)
Lat. & Lon.	12°26' to 12° 42' & 78° 9'to 78°18'
Rainfall	1068 mm
Monsoon	837 mm
Non- Mon soon	231 mm
Geology	Crystalline metamorphic gneiss complex comprising Hornblende gneiss
WATER LEVEL	
Pre - Monsoon	8 to 20 m bgl.
Post - Monsoon	5 to 15 m bgl.
GROUND WATER RESOURCES ESTIMATION	
Replenish able ground water resources	12.45 MCM
Net ground water available	11.20 MCM
Ground water draft for irrigation	29.18 MCM
Groundwater draft for domestic & industrial water supply	0.82 MCM
Total ground water draft	30.00 MCM
Stage of ground water development (%)	268
Uncommitted surface runoff available for the Firka	24.53 MCM
Total volume of weathered zone	1172.64 MCM
Total volume available for recharge considering 5 m depth from 3 m bgl	732.9 MCM
ARTIFICIAL RECHARGE /CONSERVATION MEASURES	
No. of Structures Proposed (tentative)	
Masonry Check dam –	3
Percolation Pond with recharge shaft –	3
Revival, repair of pond, tanks with recharge shaft –	8
Recharge shaft –	11
Improving Water Efficiency /Saving (Micro irrigation system for 100 ha)	0.7 MCM
Excepted groundwater recharge	1.2738 MCM
Excepted totalgroundwater recharge/saving	1.9738 MCM
Tentative total cost of the project	Rs. 4.21 Cr
Expected raise in water level by recharging/saving	0.4 m

Plan on Artificial Recharge to Groundwater and Water Conservation in Krishnagiri Firka, Krishnagiri Taluk, Krishnagiri district, Tamil Nadu

1. Introduction

India is the largest user of groundwater in the world. Food grain security of the country is largely dependent on water resources and groundwater resources play major role in irrigation sector. Imprints of Over-Exploitation on groundwater resources are being observed as steep deepening of water levels, drying of shallow groundwater abstraction structures, ingress of salinity in fresh aquifers etc. which signal towards taking necessity of emergent action for artificial recharge and rainwater harvesting by utilizing surplus runoff and maintaining groundwater resources at sustainable stage.

In Tamil Nadu dependency on groundwater has increased many folds during the recent years and the groundwater extraction for irrigation, domestic and industries have resulted in lowering of water levels, long-term water level declining trend and even drying up of wells. In order to regulate the groundwater development, Central Ground Water Board in association with State Ground Water Departments has computed Dynamic Groundwater Resources and categorized blocks as Over Exploited, Critical, Semi Critical and Safe.

Out of 1129 firkas (assessment units) in Tamil Nadu the groundwater situation in 374 firkas over-exploited, 48 firkas critical, 235 firkas semi-critical, 437 firkas safe and 35 firkas are saline. Various measures such as rainwater harvesting, artificial recharge and water use efficiency are successfully practiced by some NGOs, Central and State Govts., which need replication at larger scale in close coordination with State govt. agencies and stakeholders so that capacity building of state implementing agencies and awareness of stakeholders towards artificial recharge and rainwater harvesting can be made.

2. Objectives of the scheme

Objectives of the proposed scheme are

- To upscale recharge activities, supplement additional groundwater resources by harvesting surplus runoff, sustainability of groundwater resources at shallow depths
- Recovery of over-exploited groundwater areas by implementing artificial recharge measures in groundwater stress areas.
- Conservation, development and sustainable management of natural resources including their use.

3. Study area details

3.1 Location

The total area of Krishnagiri firka is 146.58 sq.km and Krishnagiri firka lies between North latitudes 12°26' to 12° 42' and east longitudes 78° 9' to 78° 18'. Location map of Krishnagiri firka is given in Figure 1.

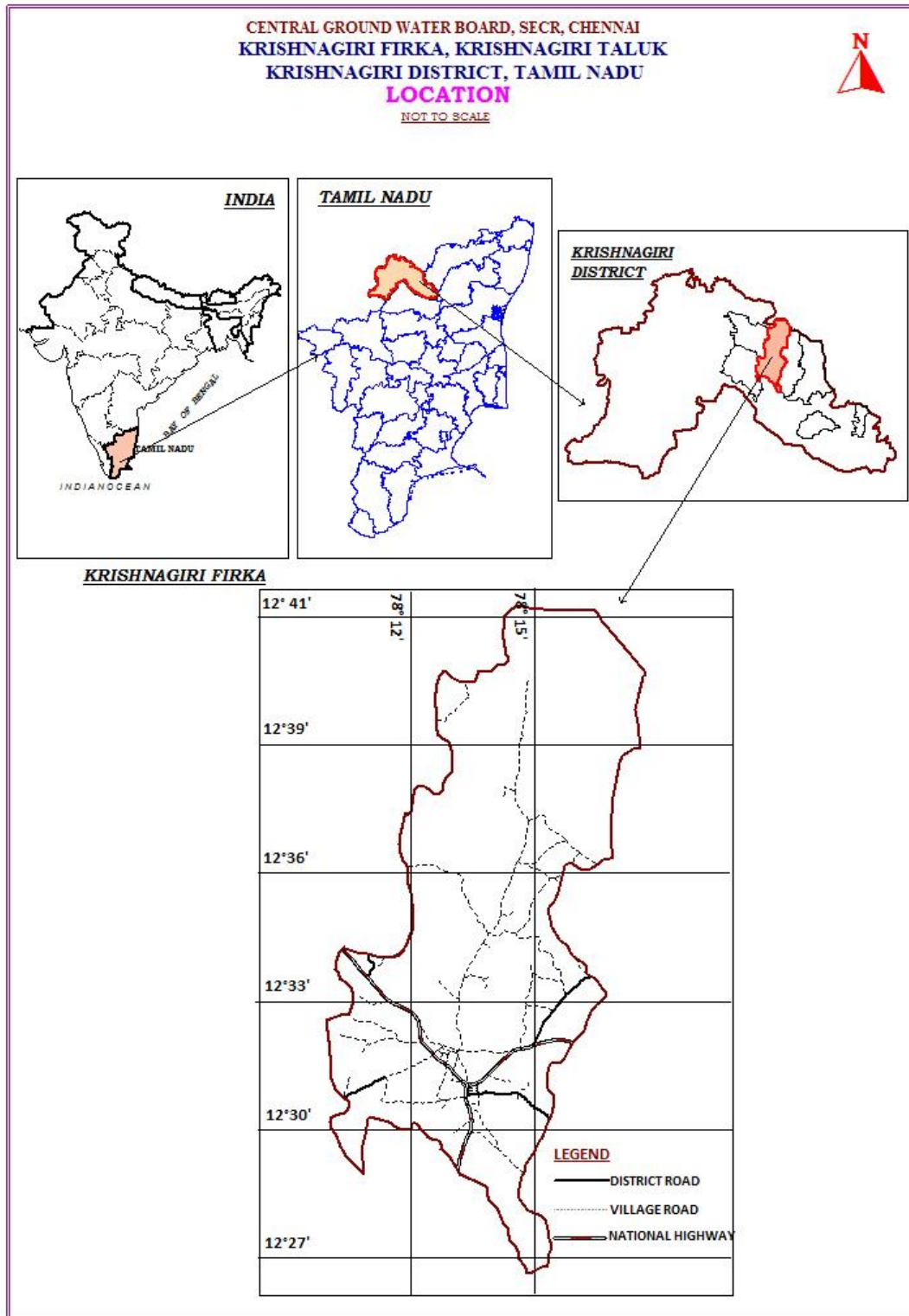

Figure 1. Location map of Krishnagiri firka

3.2 Geomorphological Set up

Geomorphologically, the area consists of hills and plain landforms. In plain landforms, Pediplain weathered moderate and shallow are occupied major part of the firka. These landforms are influencing the ground water recharge. Hill landform like residual hills, denudation hill and structural hills are act as runoff zone. (*Source: IRS, Anna University, Chennai Tamil Nadu*). Geomorphological map prepared using IRS- 1D data on 1: 50,000 scale and units are as per NNRMS standards. The range consists of a series of detached hills covered by reserved forests. The various geomorphological units with its % of coverage area are given in Table 1 and shown in Figure 2.

Table 1. Various geomorphological units with its % of coverage area in Krishnagiri firka

Landforms	% of Area
Cretaceous	1.96
Deflection Slope	8.33
Denudational Hills / Residual Hills	19.12
Dissected/Undissected	16.18
Highly Dissected	9.31
Inselberg	0.49
Moderate	5.39
Pediment-Inselberg Complex	2.45
Shallow	33.82
Structural Hills	2.45
Undissected / Less Dissected	0.49
Total	100.00

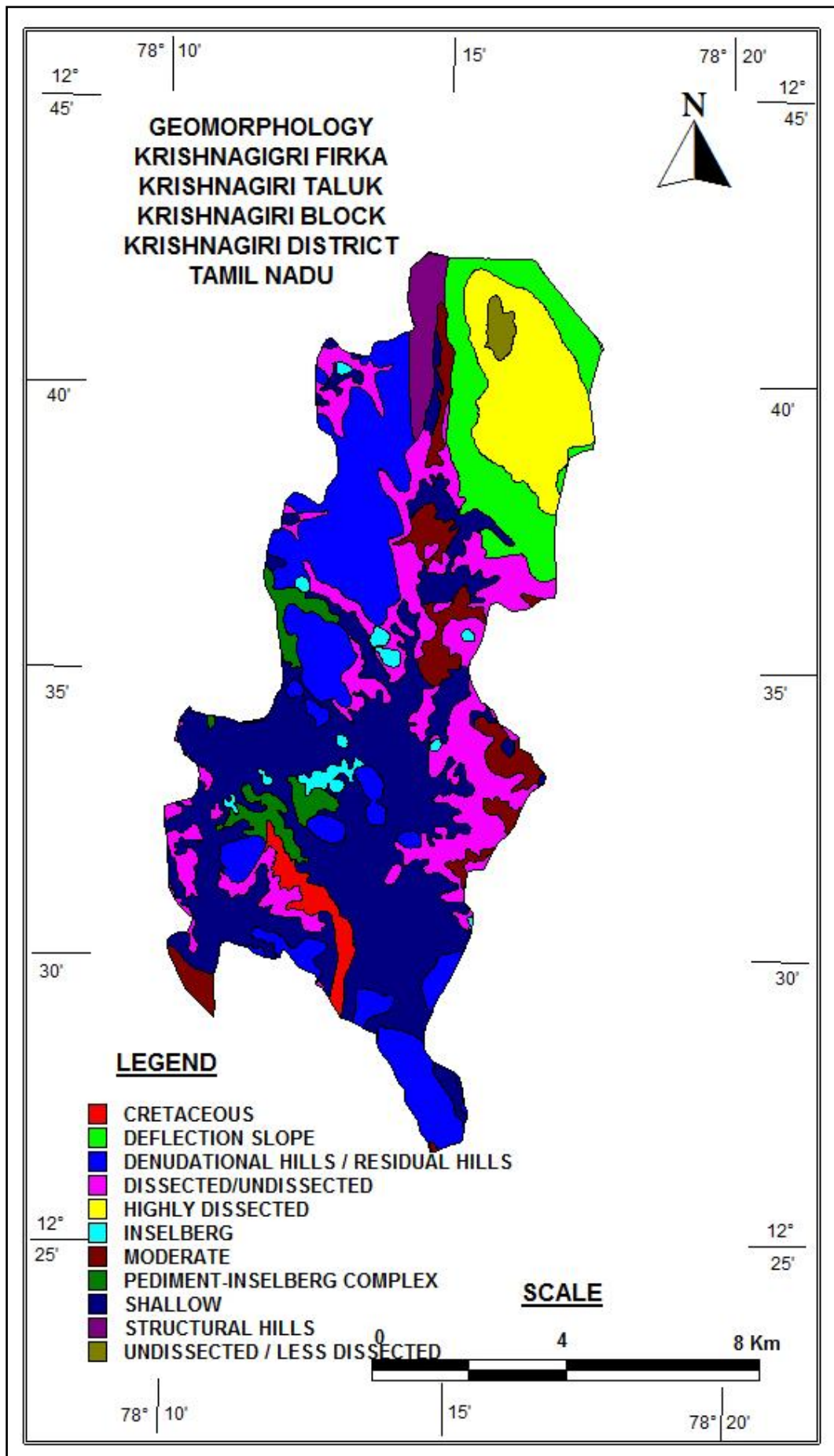

Figure 2. Geomorphology of Krishnagiri firka

3.3 Land use and soil

The land use pattern of the Krishnagiri firka is given in Figure 3. Predominantly the most of the area is characterised by the wet crop, plantation and dry crop (i.e., agricultural field) and accounts for 50 % of the total area of the firka (Source: IRS, Anna University, Chennai Tamil Nadu). This area is highly suitable for water conservation and recharge. The entire Firka is occupied by rock outcrops with loamy soil.

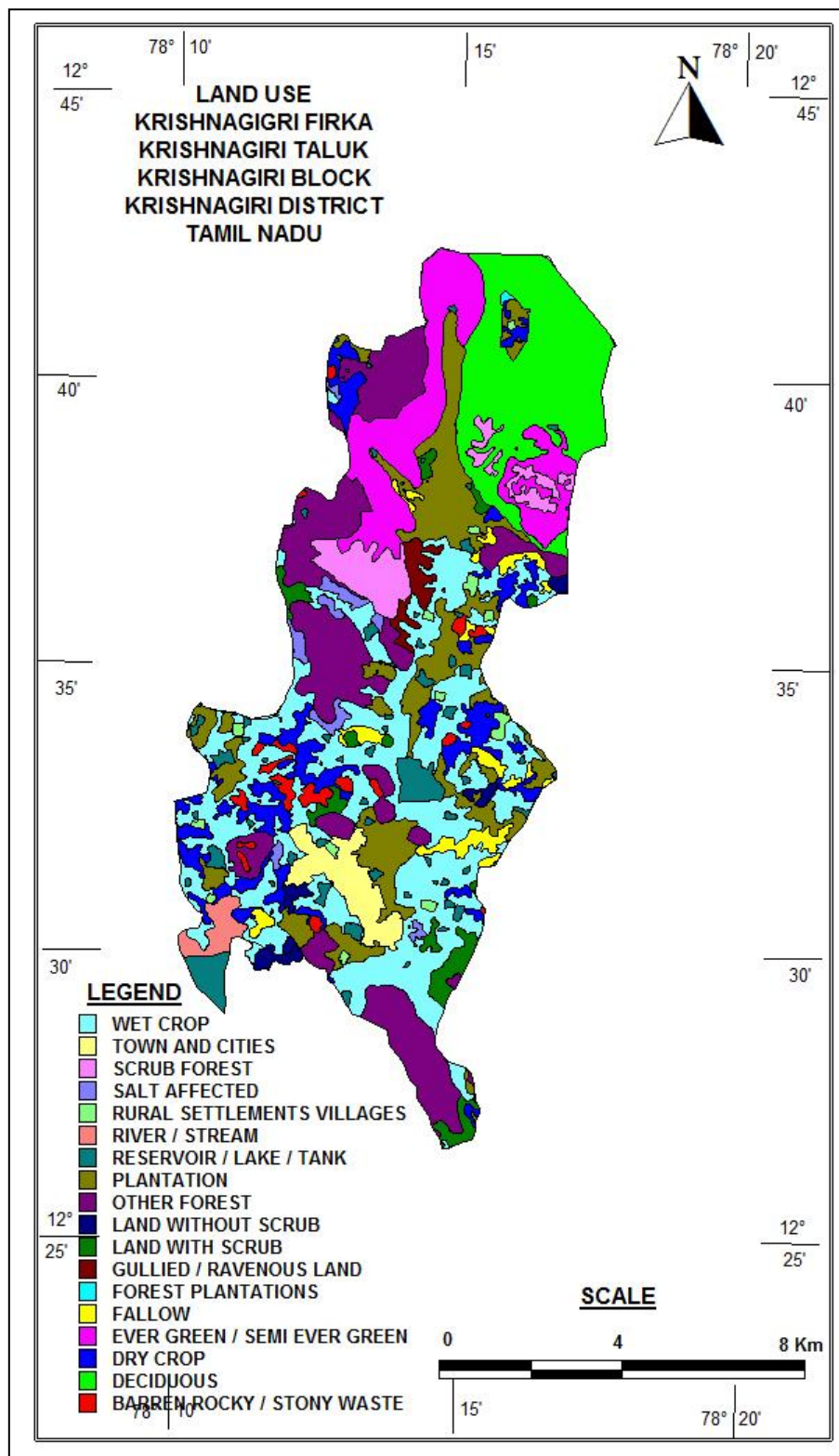

Figure 3. Landuse map of Krishnagiri firka

3.4 Drainage

The drainage pattern is the dendritic and sub-dendritic. The drainage map of Krishnagiri firka is given in Figure 4.

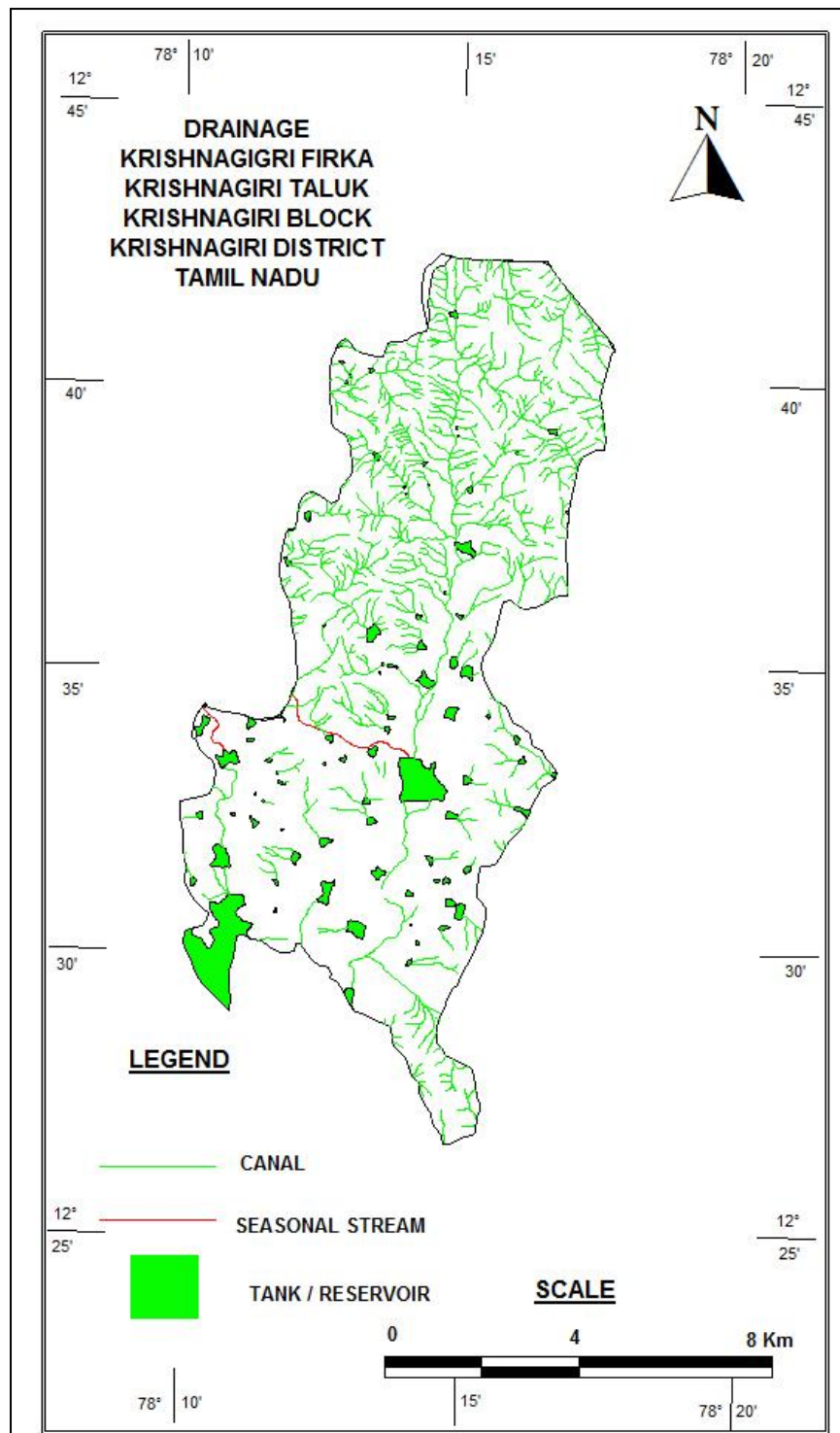

Figure 4. Drainage map of Krishangiri Firka

3.5 Rainfall

Krishnagiri area falls under tropical climate with temperature in the summer months of March to May. The average temperature varies from 26 to 41° C. The humidity is also high in the order of 80%. The wind speed is high during the months of July and August. The wind speed ranges from 7.4 to 12.6 km/hr, which increases from 100 to 120 km/hr during cyclone period. Firka receives rainfall from southwest monsoon (June – September), northeast monsoon (October – December) and non-monsoon periods (January – May). The area receives the major rainfall from northeast monsoon. Rainfall is generally heavy during low-pressure depressions and cyclones during the northeast monsoon period. The normal annual rainfall is 1068 mm.

Taluk	Name of Firka	Area in sq.km	Monsoon rainfall (Jun to Dec) In m	Non monsoon rainfall (Jan – May) In m	Total Rainfall In m
Krishnagiri	Krishnagiri	146.58	0.837	0.231	1.068

3.6 Hydrogeology

The entire firka is underlain by the crystalline metamorphic gneiss complex consisting gneisses and granites. Ground water is occurring in pheratic conditions in weathered and fractured gneiss rock formation. The weathering is highly erratic and the depth of abstraction structures is controlled by the intensity of weathering and fracturing. Large diameter dug well is more common ground water abstraction structures in the area. The diameter of the dug well is in the range of 7 to 10 m and depth of dug wells range from 15 to 18 m bgl. The dug wells yield up to 1 lps in summer months and few wells remains dry. The yield is adequate for irrigation for one or two crops in monsoon period.

The depth of wells varies from 6.64 to 17 m bgl. The hydrogeological map of Krishnagiri firka is given in Figure 5. Decadal mean water level of pre-monsoon and post monsoon are given in Figures 6 a & b. The decadal maps reveal that, mean water level during pre-monsoon in majority area is < 5 m bgl likewise during post monsoon majority part is under < 5m ground water level. The present water level in the firka is in the range of 8 to 20 mbgl (May).

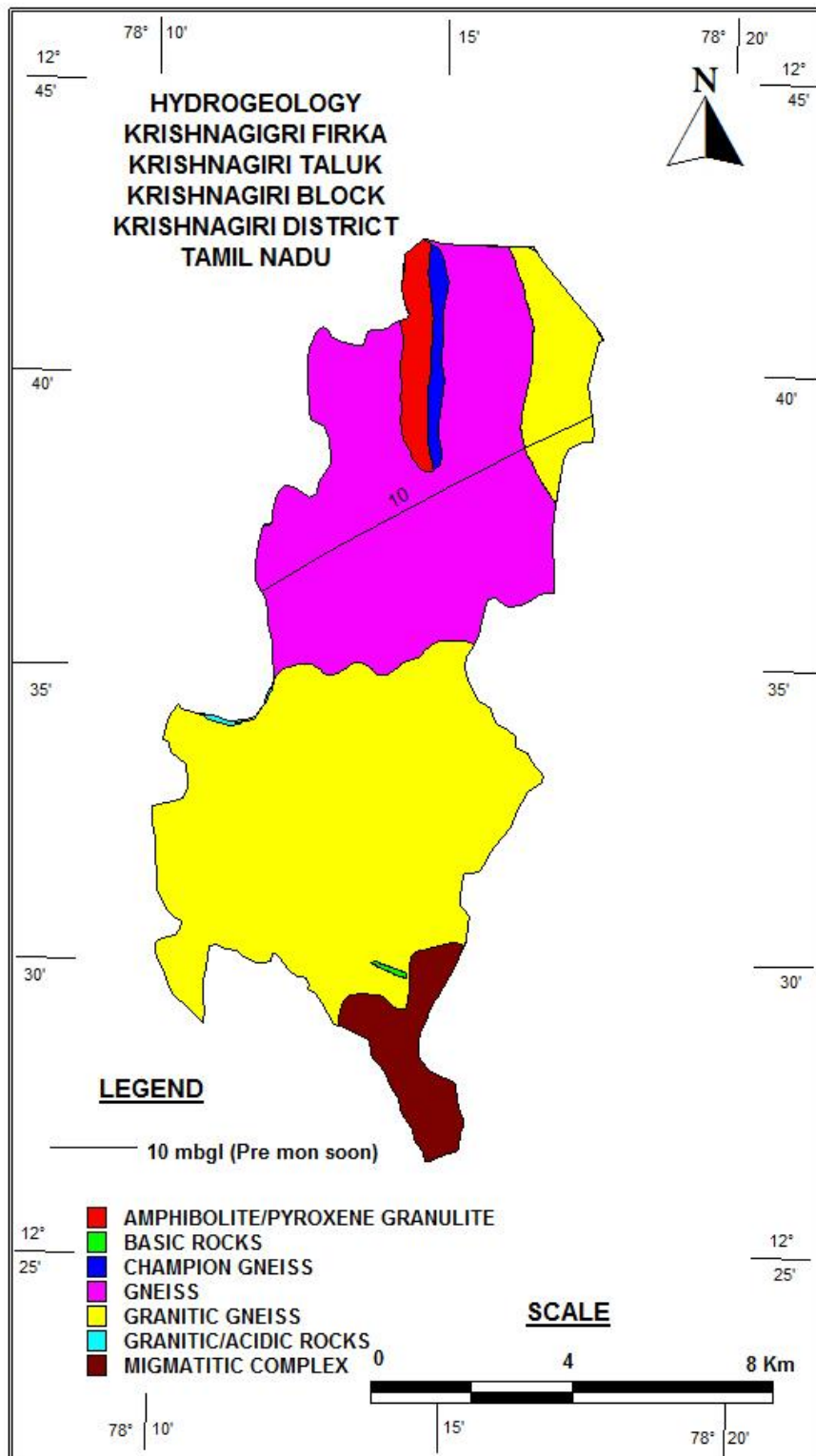

Figure 5. Hydrogeological Map of Krishnagiri firka

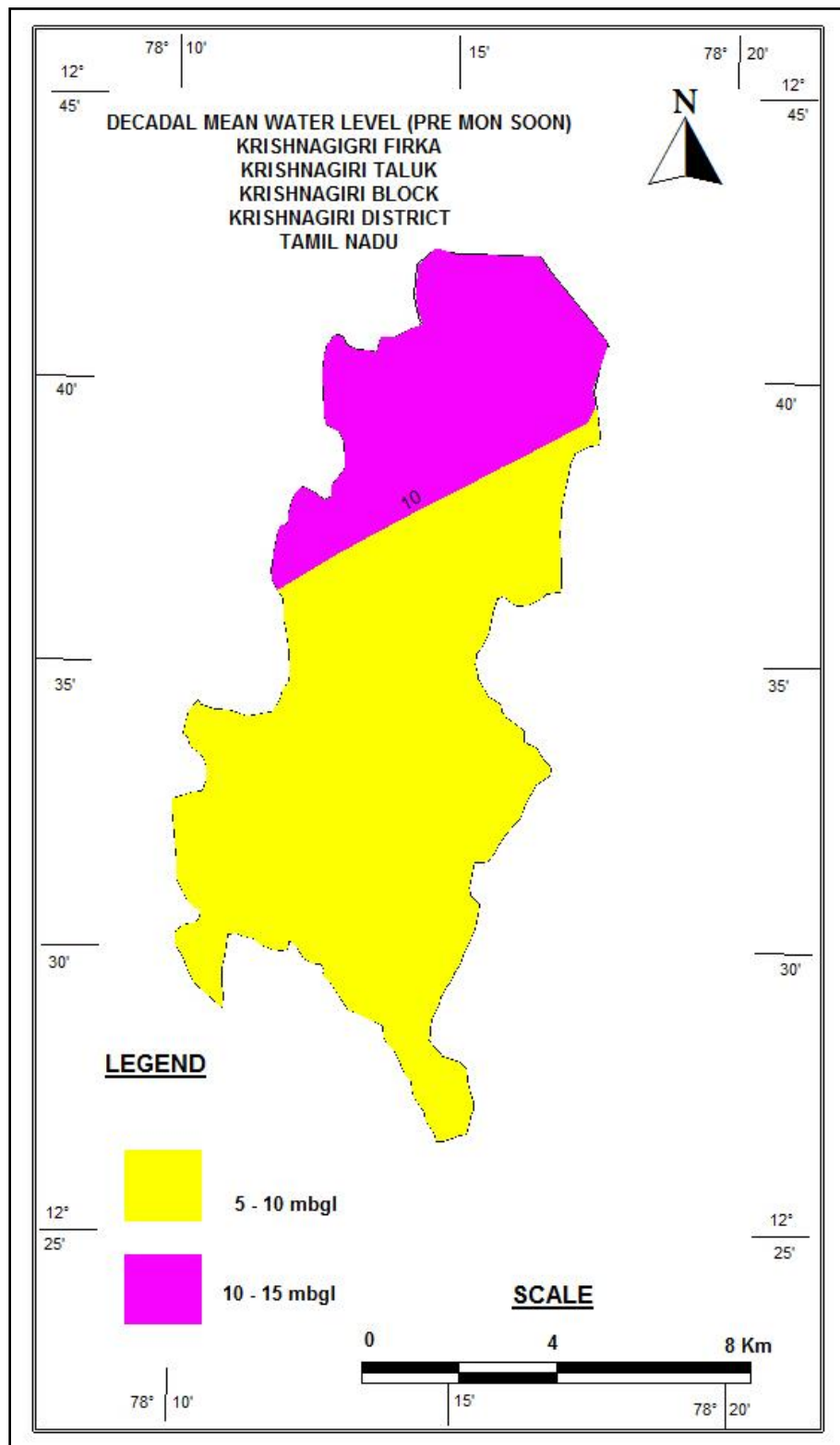

Figure 6a. Decadal Pre -monsoon water level in Krishnagiri firka

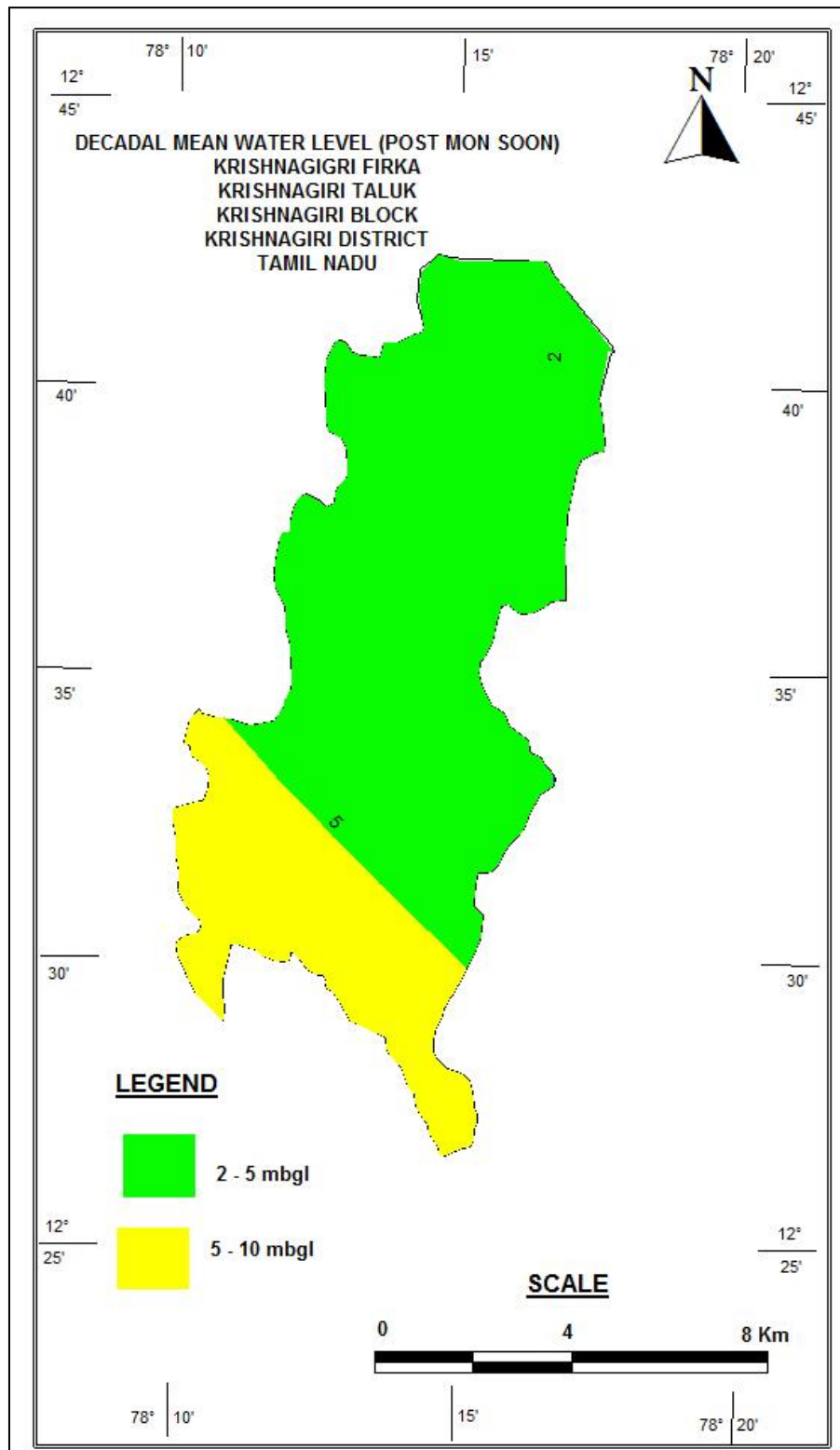

Figure 6 b. Decadal Post-monsoon water level in Krishnagiri firka

3.7 Dynamic Ground water Resources

The ground water resources have been computed jointly by Central Ground Water Board and State Ground Water Resources Data Centre (PWD, WRO, Govt. of Tamil Nadu) as on 31st March 2011. The computation has been done using GEC1997 methodology. The salient features of the computations are furnished in Table 2.

Table 2. Dynamic Ground water resources estimation of Krishanagiri firka

Firka	GW WORTHY AREA	REPLENISH ABLE GROUND WATER RESOURCES	NET GROUND WATER AVAILABLE	GROUND WATER DRAFT FOR IRRIGATION	GROUNDWATER DRAFT FOR DOMESTIC & INDUSTRIAL WATER SUPPLY	TOTAL GROUND WATER DRAFT	STAGE OF GROUND WATER DEVELOPMENT (%)	CATEGORY
	(Sq. Km)	(MCM)					(%)	
Krishnagiri	146.58	12.45	11.20	29.18	0.82	30.00	268	OVER EXPLOITED

4. Spatial Data Integration

The potential area for groundwater recharge is highly influenced by Geology, Geomorphology, Land use /land cover, Drainage, Surface Water Body, Weathered Thickness and first fractured Depth in the area. In order to ascertain the suitable area for groundwater recharge in firka, spatial data integration of have been attempted using index overlay model in GIS environ. In this model, seven layers have been integrated by assigning weightage for the theme having scale of 1-100 and sub-classes of the theme between 1 to 10 scales. The resultant map has been reclassified into four classes (High-low integrated values) indicating the suitable area for artificial recharge and given in Figure -7 and described below.

ZONE	% OF AREA COVERAGE	SIGNIFICANCE*
Very high	2	Suitable for all major recharge structures like Percolation pond and stop dam, check dam etc.,
High	28	Suitable for all major recharge structures like stop dam, check dam etc.,
Moderate	35	Suitable for all major recharge structures like earthen check dam, Boulder check dam and Nala bund etc.,
Poor	35	Hilly/Forest /Catchment area

* However, the filed verification is required to confirm above potential area for groundwater recharge.

**AREA SUITABLE FOR GROUNDWATER RECHARGE STRUCTURES
KRISHNAGIRI FIRKA, KRISHNAGIRI TALUK
KRISHNAGIRI DISTRICT
TAMIL NADU**

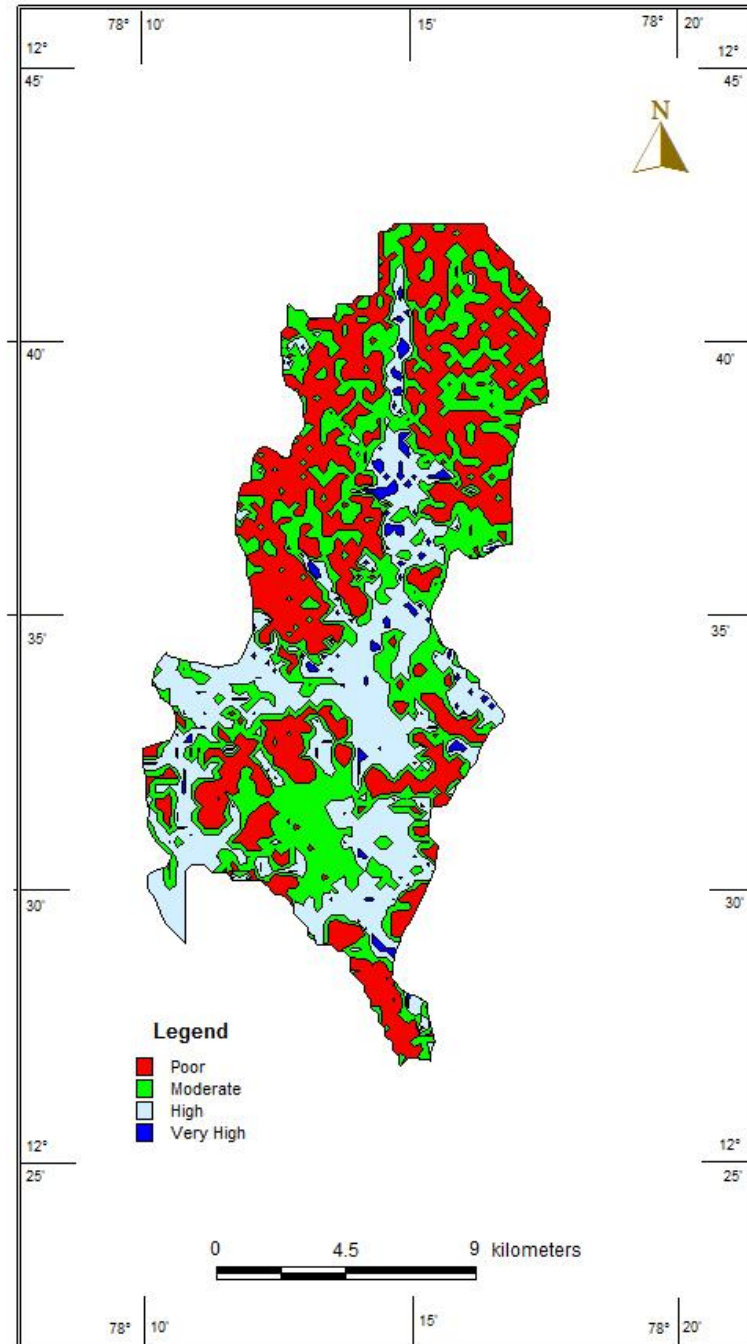

Figure -7 showing recharge worthy area

5. Planning for groundwater recharge /conservation

5.1 Justification of the artificial recharge & conservation measures

- ❖ The Firka is with high stage of groundwater development i.e., 268 % and with sufficient amount of uncommitted surface runoff/flow of 24.53 MCM.
- ❖ The total weathered zone available beneath the ground in the firka is 1172.64 MCM. Out of these total volume available for recharge is 732.9 MCM.
- ❖ The Firka consists of 97 surface water bodies /lakes and are well connected by the drainage. Revival and Recharge of these ponds will enhance the sustainability of the ground water abstraction structures.
- ❖ However, most of the ground water developments for agricultural purposes are met through dug-cum bore well and bore wells only. Hence, there is sufficient scope of recharge.
- ❖ Model generated in the areas reveals that more than 64% of areas are suitable for recharge.
- ❖ In the firka more than 65 % area is characterised by the agricultural activities, there is sufficient scope for the water conservation measures for enhance the crop production and better ground water development.

5.2 Availability of surplus surface water for artificial recharge or conservation

The uncommitted surface flow for Krishnagiri firka is estimated as per the norms followed by State Ground & Surface Water Resources data centre, PWD, Taramani, Chennai (Aug 2015). The available of surplus surface water for Krishnagiri firka is 24.53 MCM.

5.3 Proposed interventions including tentative location of artificial recharge /conservation measures

On basis of above description the following three type of approach have been made to propose artificial recharge or conservation structures.

- a. Artificial recharge
- b. Water conservation measure
- c. Water Efficiency

5.3.1 Artificial recharge

The details of artificial recharge structure proposed along with justification are given below.

5.3.1.1 Check dam

The seasonal drains in the firka carry heavy discharge during monsoon period. It is proposed that such seasonal streams / rivers will be identified and harnessed its seasonal water through construction of series of check dams. This will help in recharge to groundwater by increasing contact period between surface water and groundwater. As per the integrated model prediction around 64% of the firka areas are suitable for these structures. It is proposed to construct 3 Check

dams. The tentative location of these 3 ARs are given below. The size and location of these structures are tentative and details field survey is essential to ascertain the exact size and location.

Tentative location of proposed 3 Check dam in the firka

S. No.	Longitude	Latitude	Structures
1	78.23	12.58	Check dam
2	78.22	12.56	Check dam
3	78.24	12.59	Check dam

5.3.1.2 Recharge shaft

A recharge shaft has been proposed to facilitate the groundwater recharge in the surface water body. It has been proposed in the reservoir of the proposed revival pond and percolation pond in the firka. A total of 11-recharge shaft has been proposed in this firka. The tentative location of recharge shaft is given in the map and presented in the given table.

5.3.1.3. Revival, repair of water bodies

The village tanks and ponds are source for the groundwater recharge. Several such villages ponds/ tanks are in dilapidated condition. These existing village tanks which are normally silted and damaged can be modified to serve as recharge structure in case these are suitably located to serve as percolation tanks. Through de-silting, coupled with providing proper waste weir, the village tanks can be converted into recharge structure. The locations of about 11 existing ponds/tanks have been identified with latitude and longitude given below and marked on Plate 1. Of 11, 3 tanks/ponds have been proposed to taken up for the renovation with recharge shaft. The remaining 8 tanks falling in the very high zone have been selected for the percolation tank with recharge shaft.

Tentative location of proposed de-siltation of pond/tanks with recharge shaft

S. No.	Longitude	Latitude	Structure	Action
1	78.21	12.56	Tank / Reservoir	De-siltation And Recharge Shaft
2	78.19	12.55	Tank / Reservoir	De-siltation And Recharge Shaft
3	78.24	12.51	Tank / Reservoir	De-siltation And Recharge Shaft

Tentative location of proposed Percolation pond/tanks with recharge shaft

S. No.	Longitude	Latitude	Structure	Action
1	78.24	12.55	Tank / Reservoir	Percolation Tank With Shaft
2	78.25	12.57	Tank / Reservoir	Percolation Tank With Shaft
3	78.25	12.58	Tank / Reservoir	Percolation Tank With Shaft
4	78.25	12.58	Tank / Reservoir	Percolation Tank With Shaft

S. No.	Longitude	Latitude	Structure	Action
5	78.24	12.58	Tank / Reservoir	Percolation Tank With Shaft
6	78.22	12.56	Tank / Reservoir	Percolation Tank With Shaft
7	78.21	12.56	Tank / Reservoir	Percolation Tank With Shaft
8	78.21	12.53	Tank / Reservoir	Percolation Tank With Shaft

5.3.2 Water conservation measure

5.3.2.1 Farm Pond

A farm pond is a large dug out in the earth, usually square or rectangular in shape, which harvests rainwater and stores it for future use. It has an inlet to regulate inflow and an outlet to discharge excess water. The pond is surrounded by a small bund, which prevents erosion on the banks of the pond. The size and depth depend on the amount of land available, the type of soil, the farmer's water requirements, the cost of excavation, and the possible uses of the excavated earth. Water from the farm pond is conveyed to the fields manually, by pumping, or by both methods.

Advantages of Farm Ponds

- They provide water to start growing crops, without waiting for rain to fall.
- They provide irrigation water during dry spells between rainfalls. This increases the yield, the number of crops in one year, and the diversity of crops that can be grown.
- Bunds can be used to raise vegetables and fruit trees, thus supplying the farm household with an additional source of income and of nutritious food.
- Farmers are able to apply adequate farm inputs and perform farming operations at the appropriate time, thus increasing their productivity and their confidence in farming.
- They check soil erosion and minimize siltation of waterways and reservoirs.
- They supplies water for domestic purposes and livestock
- They promote fish rearing.
- They recharge the ground water.
- They improve drainage.
- The excavated earth has a very high value and can be used to enrich soil in the fields, levelling land, and constructing farm roads

As per the Landuse classification of the firka, majority of the area is covered by the agricultural field. Hence it is proposed to construct 100 farm ponds as per the specification of AED, Govt. of Tamil Nadu.

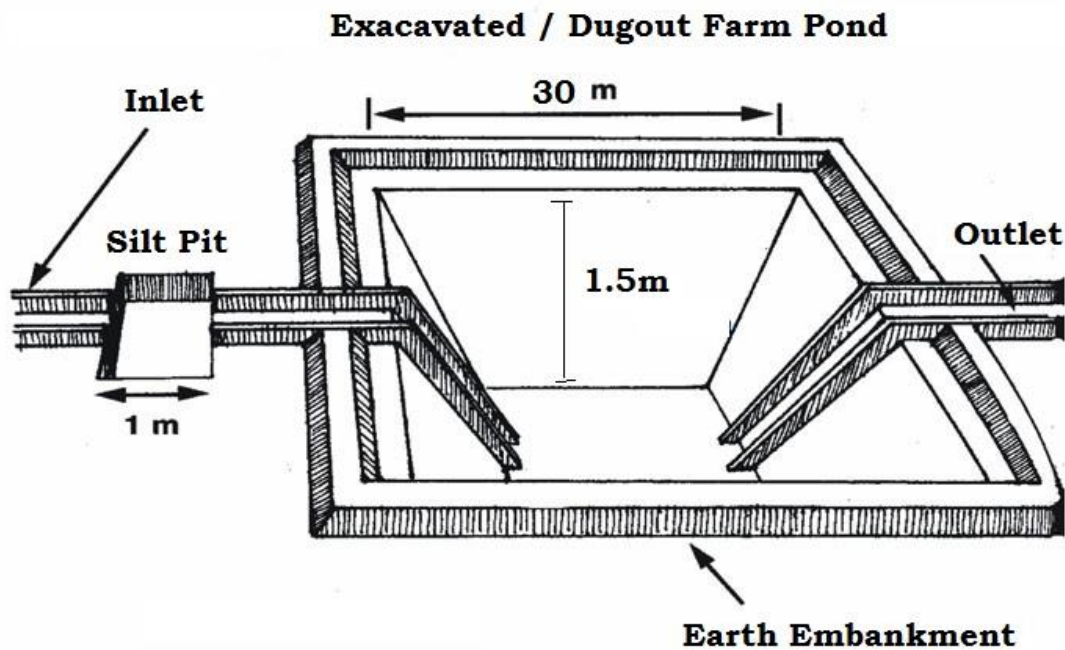

5.3.2.2. Micro Irrigation System (Sprinkler/ drip/ HDPE pipes)

Micro irrigation is defined as the frequent application of small quantities of water directly above and below the soil surface; usually as discrete drops, continuous drops or tiny streams through emitters placed along a water delivery line

In flood/furrow irrigation method more than 50% of applied water is wasted through seepage to deeper level, localized inundation causes loss through evaporation and it leaches out the nutrients from the plant. While through drip & sprinkler irrigation wastage of irrigational water could be minimized. The studies on different crops, has revealed that irrigation water is saved drastically. The conveyance losses (mainly seepage & evaporation) can be saved up to 25 to 40% through utilization of HDPE pipes. Initially the scheme is proposed to be implemented in worst affected areas showing deepest water levels and significant declining trends.

It is proposed to take up micro irrigation system in 100 ha. The cost estimation for this component has been taken from SOR of Agricultural Engineering Department (AED), Govt. of Tamil Nadu.

**ARTIFICIAL RECHARGE STRUCTURES PROPOSED
KRISHNAGIRI FIRKA, KRISHNAGIRI TALUK
KRISHNAGIRI DISTRICT
TAMIL NADU**

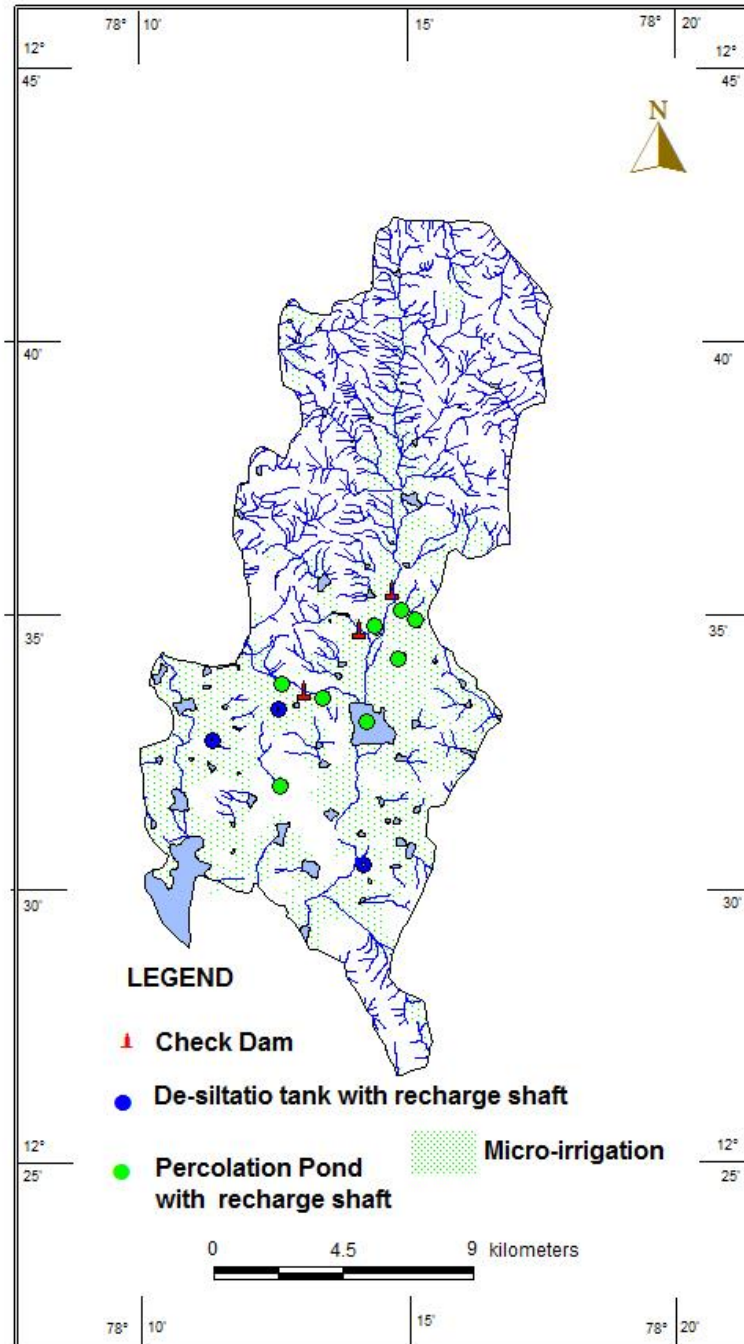

Figure - 8 Location map showing the proposed AR Structures

6. Tentative Cost Estimation

A tentative number of feasible structures, its cost and expected annual groundwater recharge / water saving is given in the Table 7. The unit rates are as followed by the PWD, Govt. of Tamil Nadu (Sources: Schedule of rates, Govt. of Tamil Nadu 2015).

Table 7. Showing the Cost Estimation of proposed Artificial Recharge Structures

Feasible Artificial Recharge & Water Conservation structures/ activities	Tentative Design	Quantity (in nos. or area in sq. m)	Total volume (Cu.m)	Tentative unit cost (Rs. lakh)	Total tentative cost (Rs. lakh)	Expected Annual GW recharge / Saving (Cu.m)
Recharge Structures/ Activities						
Masonry Check dams (5 Fillings)	Crest- 10 -15 m; Height- 1 – 1.5 m	3	51000	9	27	40800
Percolation pond	150x150x1.5m	3	303750	25.0	75	243000
Revival, repair of water bodies (3 Fillings)	(100mx100mx2.5m)	8	600000	12.0	96	480000
Recharge shaft with the pond /tanks	Recharge shaft of 1.5 m dia. With 2m depth with filter media in lower 1 m Bore dia 10" Casing 6" Depth 30 m	11		2.0	22	
Water Conservation Activities						
Farm Pond (in ha) (5 Fillings)	(30 m x 30m x 1.5 m)	100Units	600000	1	100	510000
Sprinkler/ drip/ HDPE pipes	For 1 ha with 5 m interval HDPE pipe	100 ha	100000	0.6 /ha	60	700000
Subtotal - I					380	1973800
Impact assessment and O & M						
Piezometers Up to 50 m bgl – 4 Nos. @ 0.6 lakh					2.4	
Subtotal - II					382.4	
O & M - 5 % of Subtotal - II					19.12	
Impact assessment to be carried out by the implementing agencies@ 5 % of Subtotal - II					19.12	
TENTATIVE TOTAL COST OF THE PROJECT					420.64	

Note:

- The type, number and cost of structure may vary according to site, after the ground truth verification

- CD, PC – the storage of Check Dams and Percolation Ponds is also proposed for irrigating surrounding areas for enhancing groundwater recharge as well as effective utilization of the artificial recharge structures.

7. Implication modalities

The implementation of the scheme will be done by the line department of the state selected by the respective State authority. Further, it is to add that more than 50 % MGNREGA works related to water conservation/sustainable management, accordingly a convergence guideline has been made between National Rural Employment Guarantee Act (NREGA) (Ministry of Rural Development) & Programmes of Water Resources (MoWR , RD & GR). The district Krishnagiri is one among the list of districts identified for Convergence between NREGS and schemes of MoWR. The details of permissible works under convergence are envisaged in the Joint Convergence Guideline.

a.) Time schedule

Steps	1 st Quarter	2 th Quarter	3 rd Quarter	4 th Quarter	5 th Quarter	6 th Quarter	7 th Quarter	8 th Quarter
❖ Identification of line department /implementing agency and preparation of DPR								
❖ Approval of scheme and release of sanction of funds								
❖ Implementation of ARS								

Phase = one quarter or 3 months or equivalent to financial quarter

b.) Operation and maintenance

In all projects Impact assessment has to be carried out to ensure that projects is economically viable, socially equitable and environmentally sustainable by inter-related socio-economic, cultural and human-health impacts, both beneficial and adverse. Accordingly it is proposed to have impact assessment at rate of 5 % of the total cost of the project for 5 years from the completion of artificial recharge.

8. Ground Truth Verification

The recharge zones demarcated in the map was verified in the field and it indicates that the zones identified in the map are occurring in the field. In connection with ARS, the State Government departments had already been taken up groundwater recharge works especially construction of series of Check Dam in the Firka. The other works such as percolation tank/ pond, Revival, repair of water bodies and Recharge shaft may be taken up in the Firka. The water conservation measures are essential in the Firka. Hence the proposed water conservation measures may be taken up in priority. The People in the Firka opined that the surplus water flowing in the nearby river during rainy time (Flood Season) may be diverted in the upstream side

of the Firka so that the ARS and irrigation tanks get filled and simultaneously the groundwater also get recharged. One such tank is available in the area and that can be connected from KR Dam. The length of the canal is 6 km. The cost of the canal will be estimated in consultation with PWD and other organisation.